



# FRESH PRODUCE DISPLAYS

Designers and Manufacturers of

# DISPLAY EQUIPMENT

*It's all about the Presentation*



**Fruit Separators**

**Bulk Displays Refrigeration**

**Tubs & Trays**

**Produce Displays**

**Deli Displays**

**Bakery Displays**

**Flower Displays**

**Ready-Meal Trays**

Distributed by:

# ABOUT US

**Fresh Produce Displays** is a subsidiary of Grant Austin Group Pty Ltd, an Australian-owned and operated organization established in 1973.

In 2002, the owners of Grant Austin Group Pty Ltd started **Fresh Produce Displays** with the ethos of reducing the amount of fresh produce going to landfill.

Over the last 20+ years, we have developed a range of products that not only reduce the amount of shrinkage in store but we have also been able to manufacture and supply products that give you award-winning displays. This, in turn, increases your sales whilst reducing your waste.

Our products are designed and tested to suit the Australian and New Zealand climates. We constantly innovate to ensure they are the best in the market.

*Our products offer a **proven solution** that will improve your bottom line by **increasing sales** and **reducing shrinkage**.*

## What we offer:

**Custom Design & Manufacturing**

**In-house & Overseas Production Facilities**

**Branding / Printing service**

**Injection Moulding**

**Plastic Fabrication**

**Steel Fabrication**

**Wood Fabrication**

At **Fresh Produce Displays**, we are constantly adding and updating our product range with even more revolutionary new display products (over 40 new products have been added to this catalogue).

Our friendly team has extensive knowledge and is committed to working with you to help solve your display and merchandising needs. We look forward to an exciting future together.

Call now and discover how our food display systems can transform your business.

Call us on **(08) 8347 4880**. or contact your local distributor

# INDEX

## Bags & Bag Dispensers

Cardboard Trays.....	48
Gusset Bags.....	48
Gusset Roll Bag Dispenser.....	37,47
Mushroom Bag Holder.....	48
Mushroom Bags.....	48
Star Seal Bags.....	48
Star Seal Roll Bag Dispenser.....	47

## Bakery

Bakery Cabinet.....	35
Bakery Stand.....	35
Large Shallow Tray.....	35
Polywicker Bakery Basket.....	35
Polywicker Mats.....	21,35
Polywicker Trays.....	21,35
Tongs.....	20,35
Utensil Holders.....	11,20,35

## Baskets

Polywicker Baskets.....	37,43,52-53
Polywicker Basket Island Displays.....	50-51

## Bulk Tubs and Displays

Bulk Food Tubs and Scoops.....	10,11
Bulk Tub Island Display.....	8,9
Gravity Feed - Counter Tops.....	7
Gravity Feed Bulk Tubs.....	7
Gravity Feed Wall Units.....	6
Scoops.....	10,11,20
Stainless Steel Milk Cans.....	11

## Deli

Artificial Fruit.....	14,20
Artificial Ivy.....	14,20
Cutting Board.....	20
Cutting Board Rack.....	20
Deli Bowls Black.....	15
Deli Bowls Granite-Look.....	14
Deli Bowls Speckled Black.....	12,13
Deli Bowls Terracotta.....	15
Deli Bowls White.....	14,15
Deli Bowls Woodgrain-Look.....	14
Deli Plates.....	16,17
Deli Platters.....	16,17
Deli Risers.....	18
Deli Spoons.....	14
Deli Ticketing.....	12,68-73
Dividers.....	19
Knives.....	20
Lids-Bamboo.....	12,13,14
Matting.....	21,46
Meat Tubs.....	17
Polywicker Mats.....	21,35,46
Polywicker Trays.....	21,35,46
Poultry Tubs.....	14,17
Scoops.....	10,11,20,64
Seafood Tubs.....	17
Tongs.....	20,35
Utensil Holders.....	11,20,35,64
Wooden Display Board.....	21,46

## Flower Displays

Flower Displays.....	66,67
----------------------	-------

## Fruit Separators

Soft EVA & Rigid.....	37,44-45
-----------------------	----------

## Legend Card Holders

Legend Card Holders.....	66-67
--------------------------	-------

## Matting

Matting.....	21,46
Non-Slip Matting.....	46
Polywicker Mats.....	21,35,46
Polywicker Trays.....	21,35,46
Wooden Display Board.....	21,46

## Produce Bins/ Bunks

Half-Circle Versatile cabinet.....	36,38
Bin Topper Extensions.....	42
Bin toppers.....	39,41
Produce Bins.....	38
Spill Over Brackets.....	43
Spill Over Tub.....	43
Swivel Castors.....	37,43
Ticketing for Produce Bins.....	41,42
Trolley Bumpers.....	43
Versatile Display Cabinets.....	36,37

## Produce Refrigeration

Bunchline Display.....	30
Clear-Fronted Tub.....	23
Curved Clear-Fronted Tub.....	23
Cut Fruit Trays.....	28
Dividers.....	23,24
Fabricated Clear-Front Tub.....	23
Herb Packet Trays.....	29
Hydroponic Displays.....	29,36
Lids to Suit Tubs.....	24,25
Prepacked Meat Trays.....	33
Prepacked Salad Racks.....	29
Ready Made Meal Trays.....	32
Refrigeration Ramps.....	26
Refrigeration Step Risers.....	27
Refrigeration Steps.....	27,37,39
Tubs.....	24,25

## Refrigeration Roller Mats

Roller Mats & Shelf Product Pushers.....	34
--	----

## Stand Sets - Baskets & Crates

### Mobile

Basket Stand Sets.....	54
Crate Stand Sets.....	56-57
Produce Carton Stand Sets.....	55

### Free Standing

Wooden Floor Stand.....	58,65
Wooden Counter Stands.....	59

## Wooden Barrels & Stands

Barrel Lids.....	11,64
Barrel Tubs.....	11,64
Metal Barrel Stand Extensions.....	65
Metal Barrel Stands.....	65
Wine Bottle Drawstring Bags.....	65
Wooden Barrels.....	11,29,64
Wooden Legs to suit Barrels.....	64

## Wooden Crates

Crate Liners.....	60-63
PolyCarb Lids.....	60-61,63
Wooden Crates.....	37,43, 60-63,65

## Ticketing

Chalk Boards.....	35,72-74
Deli Ticketing.....	12,68-73
Framed Ticketing.....	68
Free Standing Signage and Ticketing.....	72
Hanging Ticketing.....	61,69
Liquid Chalk.....	74
Pop Clips.....	35,61,70-71

## Wood Wool

Wood Wool.....	21,65
----------------	-------

# Creating Solutions - Concept to In-store

*We can help you bring your ideas to life!*

**Concept**



**Design**



**Manufacture**

2D & 3D Drawings

3D Rendering

Tooling

Forming

Fabrication

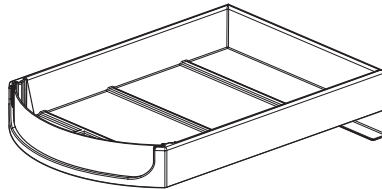
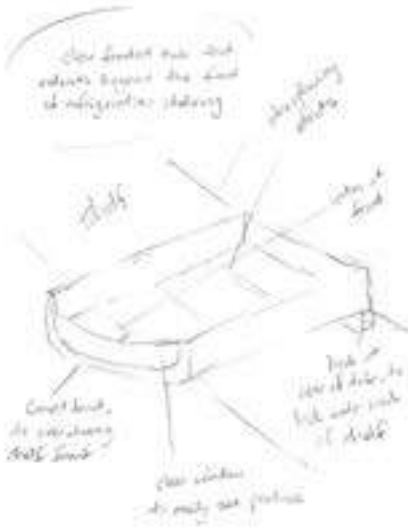

2D Drawing



3D Render



VT64C



# Colours & Materials Available

## Refrigeration Tubs, Ramps & Trays



Light  
Wood-Grain



Dark  
Wood-Grain

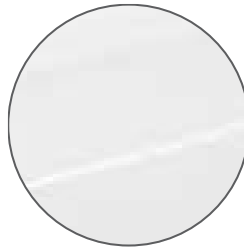

White



Black

## Wooden Crates

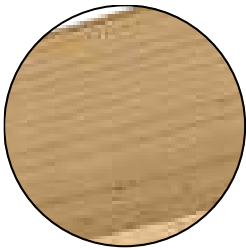

Aged

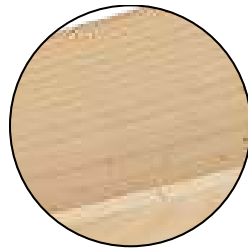

Natural

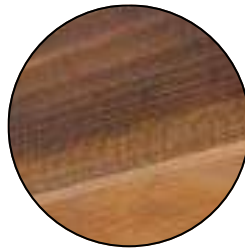

Dark Stain

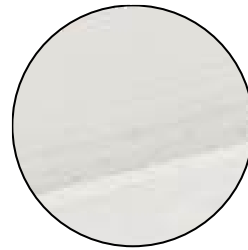

White-Wash



Black

## Polywicker Baskets

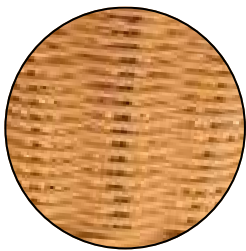

Natural

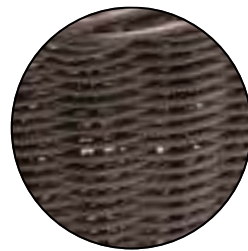

Chocolate



Earth

## Materials

- **ABS:** Foodgrade ABS impact resistant, high strength. Pattern finish to hide scratches.
- **POLYCARB:** Impact and solvent resistant, greater strength than Acrylic.
- **ACRYLIC:** Clear, shinier and more Rigid than Polycarb.
- **EVA:** an antibacterial closed-cell foam. It is a flexible, lightweight, buoyant material that protects the produce.

# Gravity Feed - Wall Units

- Reduce plastic from packaging
- 2 heights depend on what you need
- Both fitted with spill-trays

## Gravity Feed Bulk Tub Wall Unit - 273 Litres

Complete with 21 tubs -

6 x BT003-GF

15 x BT002-C

1040 x 650 x 2300mm (WxDxH)

**BTS006-MC**



**Clear Gravity Feed Tub - 13 Litre  
BT003-GF**

## Gravity Feed Bulk Tub Half-Wall Unit - 208 Litres

Complete with 16 tubs -

6 x BT003-GF

10 x BT002-C

1040 x 580 x 1670mm (WxDxH)

**BTS007-MC**

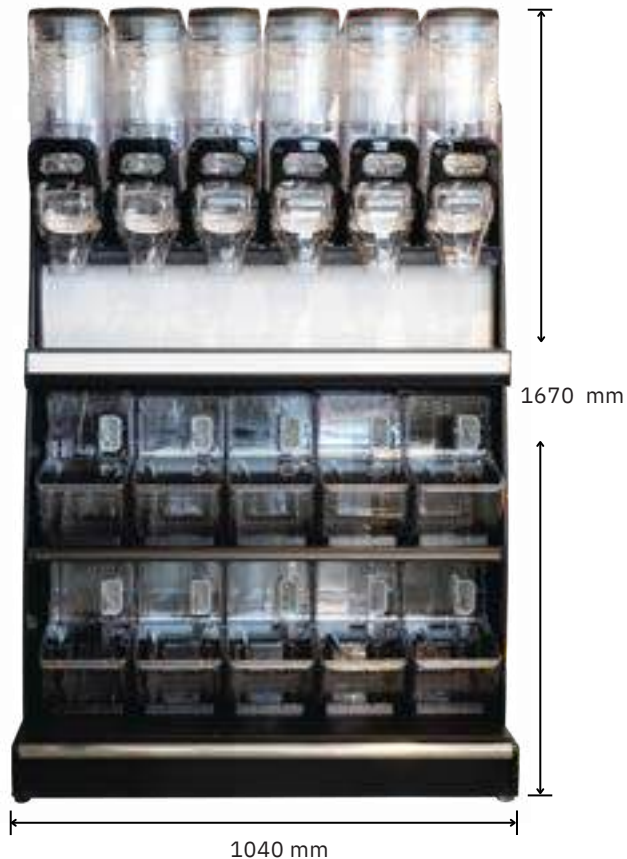
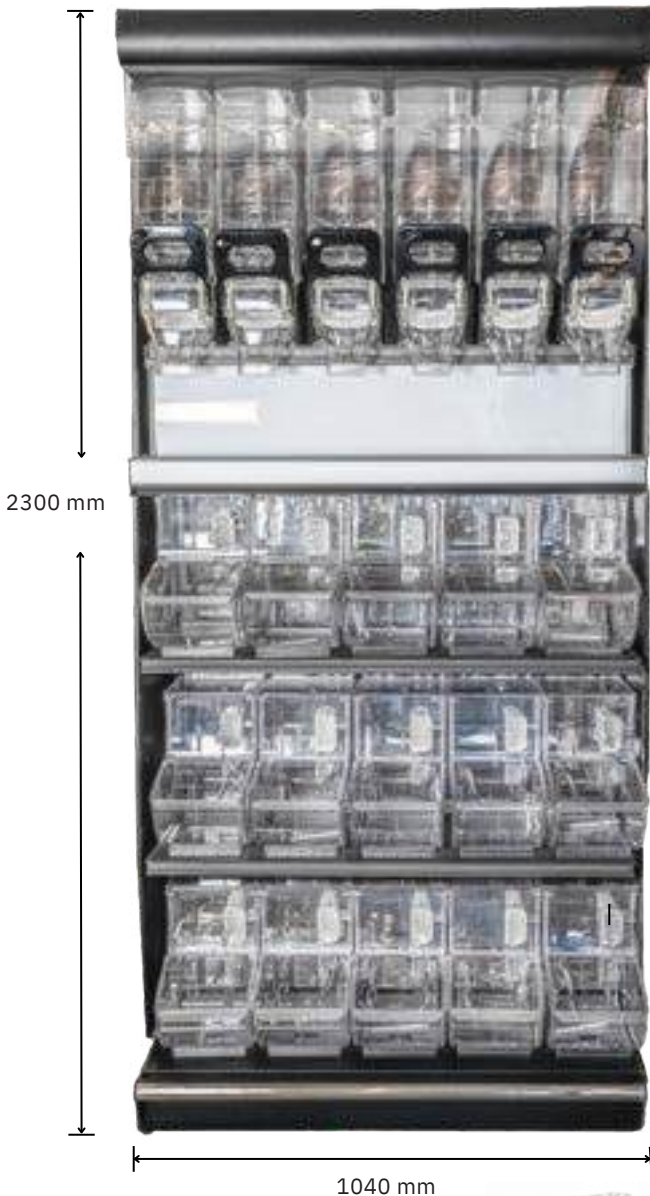

## Bulk Tub - Clear with Soft Closing Lid - 13 Litre

*With internal scoop holder & clear scoop*

**BT002-C**

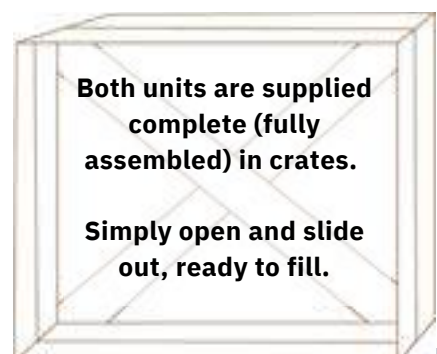

**Both units are supplied complete (fully assembled) in crates.**

**Simply open and slide out, ready to fill.**

(All dimensions in millimetres - width x depth x height)

FPD0624

# Gravity Feed - Counter Top Units

- Made from foodgrade materials
- Gravity Feed units come standard with foot to sit on bench. Mounting points fitted in foot
- Optional wall-mounting bracket (suits both gravity feed tubs, BT003-GF & BT004-GF) (Bolts & screws not provided)

## Gravity Feed Bulk Tub Counter Unit

Complete with 2 tubs -

2 x BT003-GF

45 x 455 x 790mm (WxDxH)

**BTS008-GF**

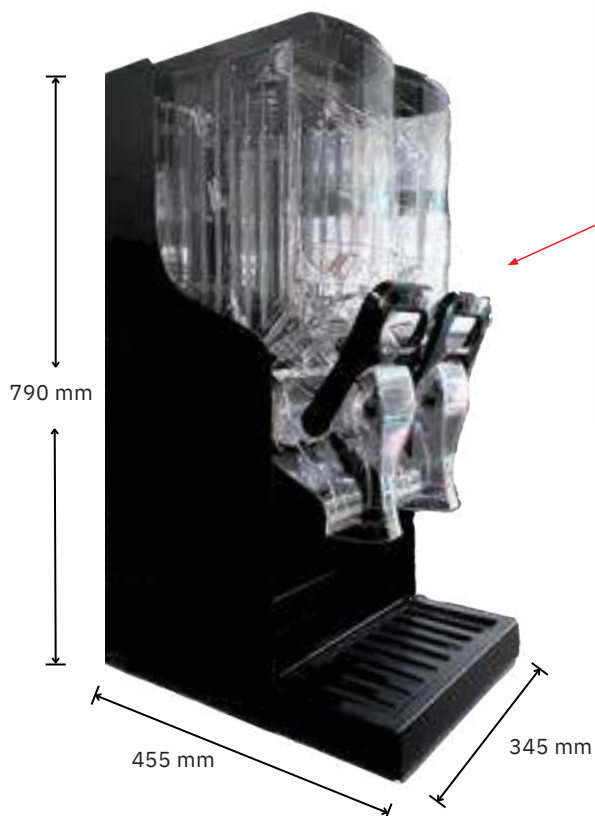

**Clear Gravity Feed Tub - 13 Litre**  
(2 included with *BTS008-GF*)  
**BT003-GF**

*(Custom made Cabinet / Stand available on request)*

BTS008-GF in store



## Free-Standing Bench Units & Gravity Wall-Mount Bracket



**Clear Gravity Feed Tub - 13 Litre**  
152 x 340 x 570mm  
**BT003-GF**



**Clear Gravity Feed Tub - 19 Litre**  
152 x 340 x 710mm  
**BT004-GF**



**Wall-Mount Metal Bracket**  
for BT003-GF & BT004-GF bulk tubs  
**BT003-Bracket** (optional extra)



**Example of BT003-Bracket on BT003-GF Gravity feed bulk food tub (optional extra)**

# Bulk Tub Island Display

- Create an eye-catching island display
- Helps minimise packaging waste
- Easy to use & refill
- Panel-lift door on the front of BTS010-NC Straight-Stepped Unit to access bulk display and storage area

**Modular - combine Half-Circle units with straight units according to your needs**

**Example layout below**

2 x BTS004-NC 3-Tier Half-Circle Display  
4 x BTS010-NC 3-Tier Straight Stepped Unit



**All units available separately**





# Bulk Tub Island Display



**Bulk Tub - Clear with Soft Closing Lid - 5.5 Litre BT010-C**



**Bulk Tub - Clear with Soft Closing Lid - 7.5 Litre BT009-C**

**Open Utensil Tubs**

## 3-Tier Half-Circle Display - 93 Litre

Complete with 16 tubs -  
2 x utensil tubs  
6 x BT010-C  
8 x BT009-C

*Base supplied assembled in crate*

1500 x 750 x 1200mm

**BTS004-NC**

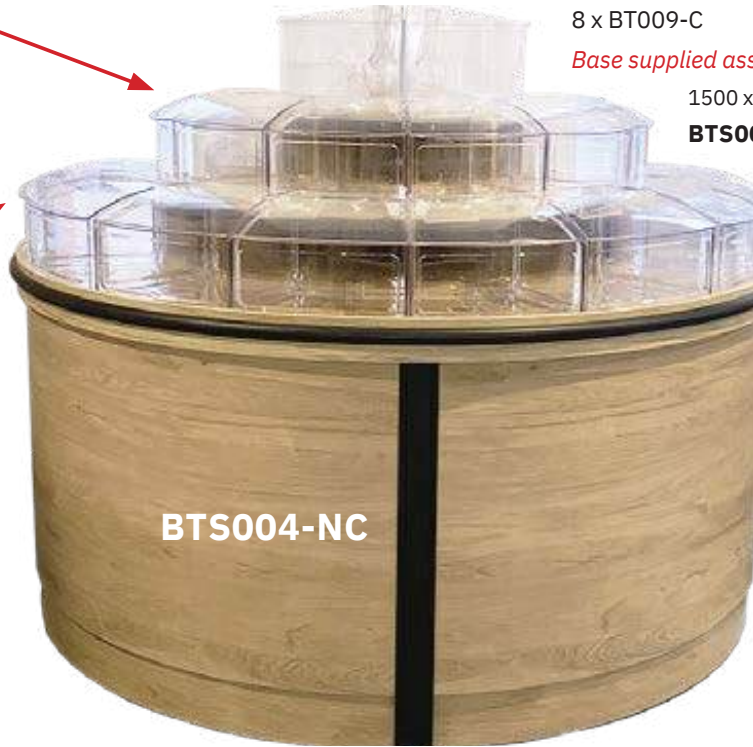

**BTS004-NC**

**These units are perfect for backing against a wall**



**Bulk Tub - Clear with Soft Closing Lid & Scoop - 8 Litre BT007-C**



**Scoop - Clear 235mm FS235-C**

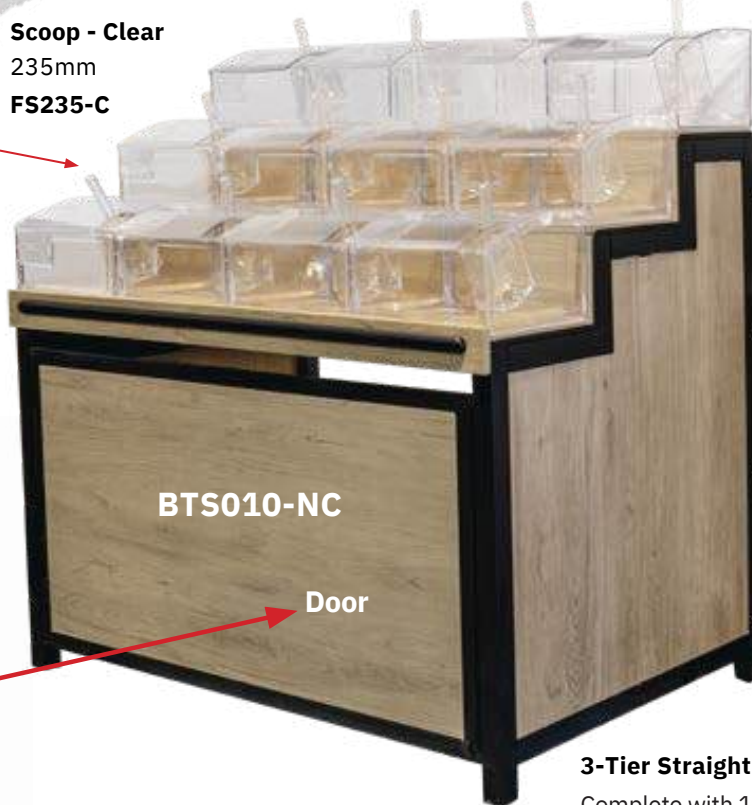

**BTS010-NC**

**Door**

**Lift up and slide in to access storage/bulk display area.**

## 3-Tier Straight Stepped Unit - 96 Litre

Complete with 12 tubs -  
12 x BT007-C

*Supplied flat-packed, with assembly instructions*

*(10 minute assembly)*

1200 x 750 x 1200mm

**BTS010-NC**



# Bulk Food Tubs & Scoops

- Made from clear foodgrade plastic



**Bulk Tub - Clear - 13 Litre**  
 With soft closing lid, internal scoop holder & clear scoop with bungee cord  
 Top fill for stock rotation

200 x 400 x 330mm  
**BT002-C**



**Bulk Tub - Clear - 22 Litre**  
 With soft closing lid, internal scoop holder & clear scoop with bungee cord  
 Top fill for stock rotation & Label holder in lid  
 Optional divider to create 2 side by side compartments

300 x 420 x 340mm  
**BT001-C**

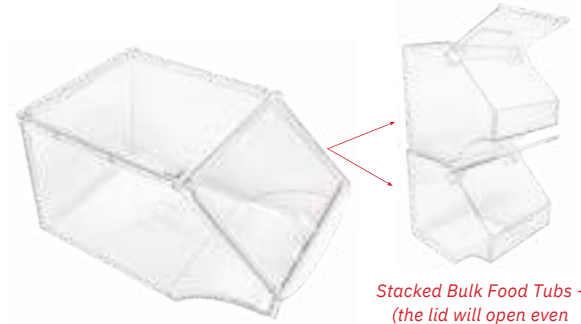

Stacked Bulk Food Tubs -  
 (the lid will open even when stacked)

**Stackable Bulk Tub - 4.8 Litre**  
 With front-opening lid  
 200 x 300 x 165mm  
**BT058-C**



**Clear Scoop**  
 235mm - **FS235-C**



**Stainless Steel Scoop**  
 75 x 225 x 45mm - **FS225-SS**

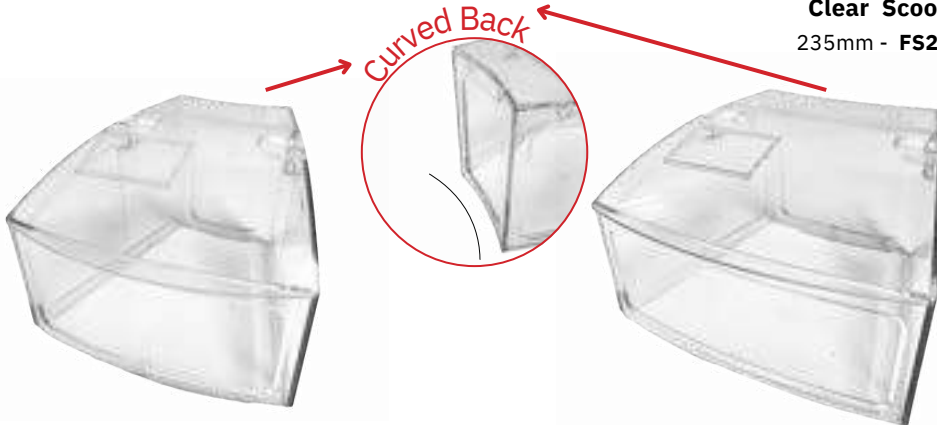

Curved Back

**Curved Bulk Tub - Clear - 5.5 Litre**  
 With soft closing lid with product label holder

255-130 x 250 x 180mm  
**BT010-C**

**Curved Bulk Tub - Clear - 7.5 Litre**  
 With soft closing lid with product label holder

290-195 x 250 x 180mm  
**BT009-C**



**Bulk Tub - Clear - 8 Litre**  
 With soft closing lid, internal scoop holder & clear scoop with bungee cord

290 x 250 x 180mm  
**BT007-C**

## Airtight Containers



**Slanted-Top Round Bulk Tub - Clear - 8 Litre**  
 With hinged lid

230 Ø x 200-250mm  
**BT057-C**



**Bulk Tub - Clear - Cookie Jar - 8 Litre**  
 230 Ø x 282mm  
**BT011-C**



**Bulk Tub - Clear - Cookie Jar - 13.5 Litre**  
 Can stand upright or on its side

240 x 300 x 340mm  
**BT012-C**



**Customised Display Unit for Bulk Food Tub**

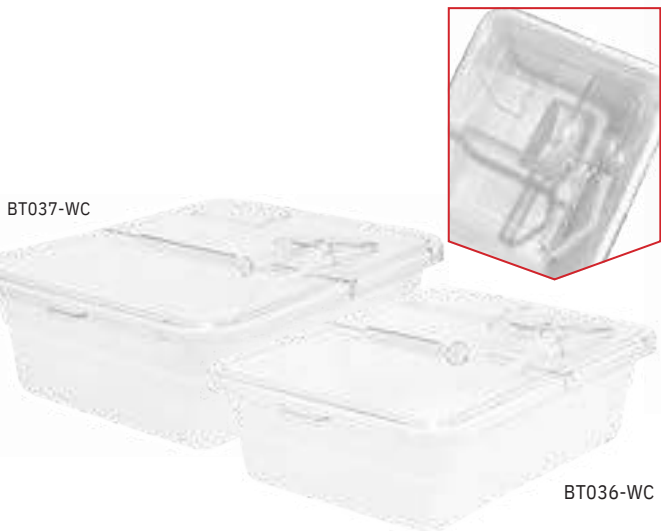

BT037-WC

BT036-WC

**Bulk Tub - White Plastic with Clear Lid, Scoop Holder & Clear Scoop**

*With middle-hinged lid, clear scoop with bungee cord & label holder*

- 6 Litre - 260 x 330 x 100mm - BT036-WC**
- 13.5 Litre - 350 x 440 x 140mm - BT037-WC**



BT020-WC

BT040-WC

**NEW**

**Mobile Bins - White Plastic with Clear Lid & Wheels**

- 20 Litre - 255 x 360 x 450mm - BT020-WC**
- 40 Litre - 360 x 510 x 450mm - BT040-WC**



**Barrel Lids - Clear Polycarb**

- VLA320 (Fits BAR320 barrel)**
- VLA370 (Fits BAR370 barrel)**



FS225-SS



**Utensil Holder (tongs / scoops)**

*Hang on baskets, crates, display stands, etc*

- 125 x 85 x 155mm**
- Black - VUH2-B**
- White - VUH2-W**



**Milk Can - Stainless Steel - 10 Litre**

*Latched lid with - Pressure valve*  
**304 Stainless Steel**

- 210 x 230 x 310mm**
- BL002-SS**



**Milk Can - Stainless Steel - 20 Litre**

*Latched lid with - Pressure valve*  
**304 Stainless Steel**

- 250 x 320 x 430mm**
- BL004-SS**



*Foodgrade, will hold water*

**Barrel Tubs - Foodgrade**

- BARTUB320 (Fits BAR320 barrel)**
- BARTUB370 (Fits BAR370 barrel)**



**Wooden Barrels**

- 330mm Ø x 240mm H - BAR320**
- 380mm Ø x 270mm H - BAR370**

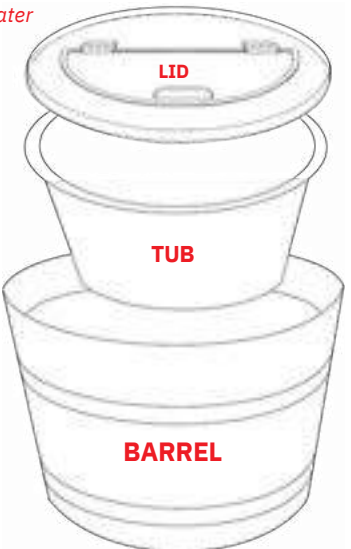

LID

TUB

BARREL

# Speckled Black Melamine Deli Bowls

- Uniform Sizing, maximises space usage
- Various heights
- They are all reversible, to allow you to use the bowl as a riser or a platter
- Stackable
- Bamboo lids are available for all bowls in this range
  - This allows for better stacking in the coolroom at night
  - The lids can also be used separately as display trays

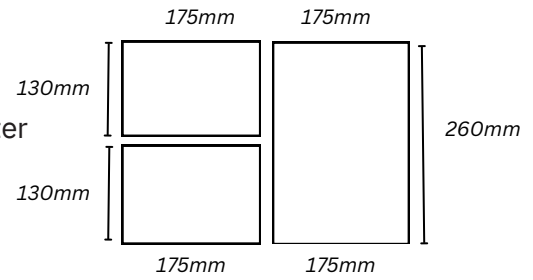

## 175 x 130mm Range



**Shallow Melamine Deli Bowl Black Speckled - Reversible**

175 x 130 x 40mm

**DB17134GW**

**Medium Melamine Deli Bowl Black Speckled - Reversible**

175 x 130 x 70mm

**DB17137GW**

**Deep Melamine Deli Bowl Black Speckled - Reversible**

175 x 130 x 100mm

**DB171310GW**

**Bamboo Lid / Serving Platter**

*Bamboo lid fits 175 x 130mm bowls*

**DB1713-L**

## 260 x 175mm Range

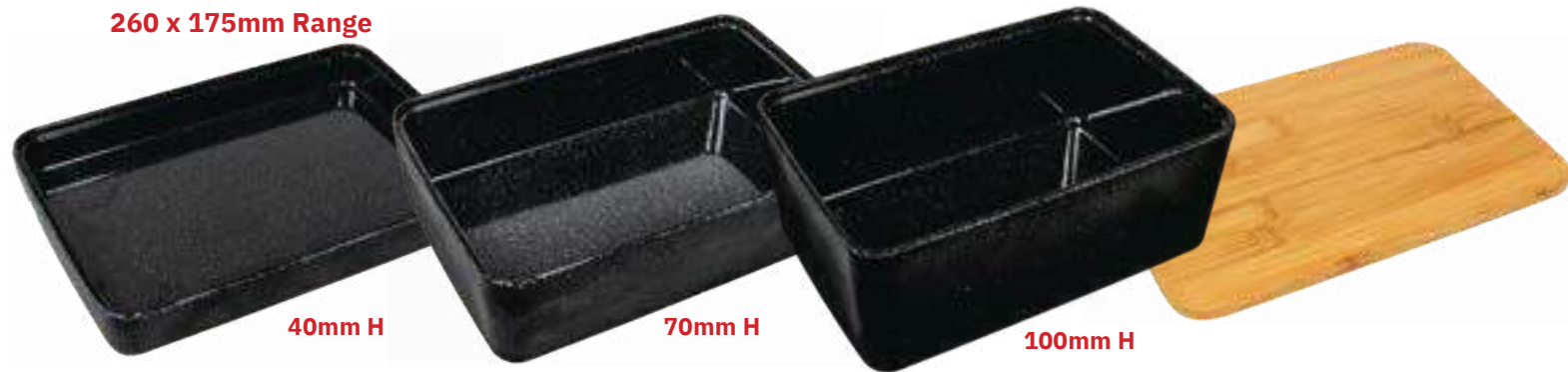

**Shallow Melamine Deli Bowl Black Speckled - Reversible**

260 x 175 x 40mm

**DB26174GW**

**Medium Melamine Deli Bowl Black Speckled - Reversible**

260 x 175 x 70mm

**DB26177GW**

**Deep Melamine Deli Bowl Black Speckled - Reversible**

260 x 175 x 100mm

**DB261710GW**

**Bamboo Lid / Serving Platter**

*Bamboo lid fits 260 x 175mm bowls*

**DB2617-L**

Recommended Deli Ticketing. More details page 73



**THSS50-FS**



**THSS100-FS**



**DBTH100-FS**



**DBTH120-FS**

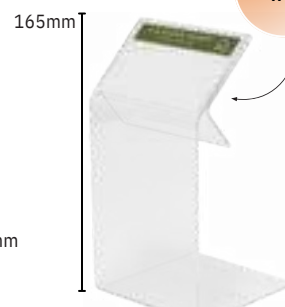

**DTHA8-FS**



**DTC115-C**

FPD0624

(All dimensions in millimetres - width x depth x height)



*Bowls are stackable, even with the bamboo lids on. Enables easy cool room storage*

*Reversed Deli Bowl used as a riser*



*Stackable, for easy storage*

**345 x 260mm Range**



**40mm H**

**70mm H**

**100mm H**

**Shallow Melamine Deli Bowl Black Speckled - Reversible**

345 x 260 x 40mm

**DB34264GW**

**Medium Melamine Deli Bowl Black Speckled - Reversible**

345 x 260 x 70mm

**DB34267GW**

**Deep Melamine Deli Bowl Black Speckled - Reversible**

345 x 260 x 100mm

**DB342610GW**

**Bamboo Lid / Serving Platter**

*Bamboo lid fits 345 x 260mm bowls*

**DB3426-L**

**520 x 175mm Range**

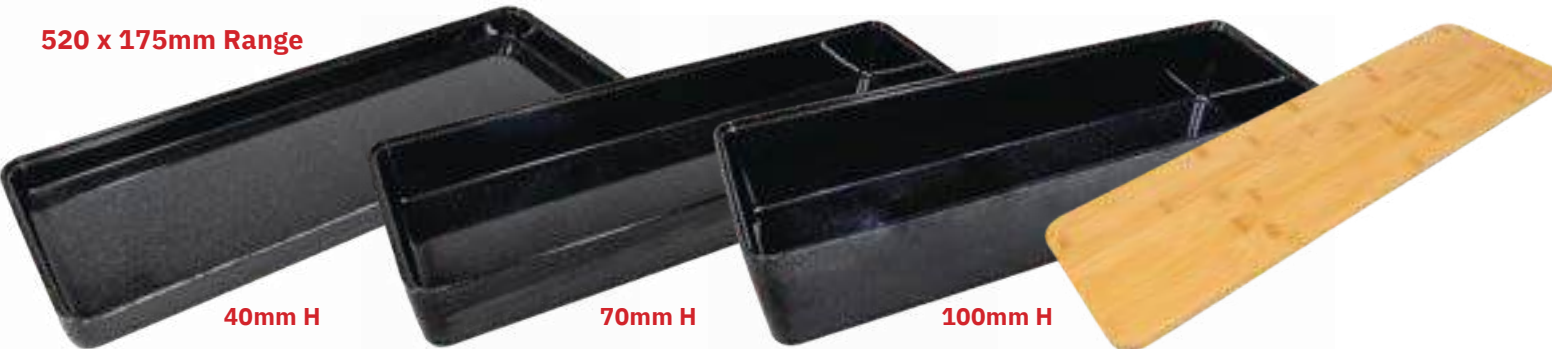

**40mm H**

**70mm H**

**100mm H**

**Shallow Melamine Deli Bowl Black Speckled - Reversible**

520 x 175 x 40mm

**DB52174GW**

**Medium Melamine Deli Bowl Black Speckled - Reversible**

520 x 175 x 70mm

**DB52177GW**

**Deep Melamine Deli Bowl Black Speckled - Reversible**

520 x 175 x 100mm

**DB521710GW**

**Bamboo Lid / Serving Platter**

*Bamboo lid fits 520 x 175mm bowls*

**DB5217-L**



# Woodgrain-Look Deli Bowls, Platters & Accessories

- Enhance the colour of your display with the woodgrain-look without compromising the colour of the food inside the white interior



**Woodgrain-Look Melamine Bowl - 1 Litre**  
180 x 165 x 80mm  
**DB3001-WG**

**Bamboo Lid**  
180 x 165 x 10mm  
**DB3001WG-L**



**Woodgrain-Look Melamine Bowl - 1.5 Litre**  
270 x 165 x 80mm  
**DB3002-WG**

**Bamboo Lid**  
270 x 165 x 10mm  
**DB3002WG-L**



**Woodgrain-Look Melamine Bowl - 2 Litre**  
325 x 165 x 80mm  
**DB3003-WG**

**Bamboo Lid**  
325 x 165 x 10mm  
**DB3003WG-L**



**Woodgrain-Look Melamine Bowl - 2.5 Litre**  
325 x 265 x 80mm  
**DB3004-WG**

**Bamboo Lid**  
325 x 265 x 10mm  
**DB3004WG-L**



**Woodgrain-Look Long Melamine Bowl**  
530 x 160 x 75mm  
**DB3005-WG**



**White Melamine Bowl**  
530 x 160 x 75mm  
**DB53168W**



**Long-Handle Serving Spoons**  
380 x 70mm  
Non-perforated - **SP387-W**  
Perforated - **SP387S-W**



**Melamine Tray**  
265x 160 x 40mm  
**DB2001-WG**



**Melamine Tray**  
320 x 265 x 40mm  
**DB2002-WG**

## Granite-Look Deli Bowls



**Granite-Look Melamine Bowl 2 Litre**  
240mm Ø x 105mm  
**DB2410M**



**Granite-Look Melamine Bowl 3.2 Litre**  
280mm Ø x 120mm  
**DB2812M**



**Artificial Boston Ivy**  
152cm garland  
**Ivy-Boston**

**Artificial Grape Bunches**  
Wine - **Grape-LW**  
Yellow - **Grape-LY**

# Melamine Deli Bowls, Clear Lids & Dummy Bases



- Foodgrade melamine & ABS
- Dummy Bases can be made to fit any bowls:
  - Maintain consistent height
  - Minimize wastage by displaying only what you need
- Recommended Deli Ticketing see page 68-73
- Uniform Sizing

Use the insert to make the bowl look full with less product.



## Rectangular Melamine Bowl

230 x 115 x 65mm

Black - **DB115-65-BK**  
White - **DB115-65-WH**

## Rectangular ABS Deli Bowl / Insert

*Use alone, or as a dummy base for DB115-65 bowls*

230 x 115 x 45mm  
Black - **DB115S-BK**  
White - **DB115S-WH**



## Square Melamine Bowl

230 x 230 x 65mm

Black - **DB230-65-BK**  
White - **DB230-65-WH**

## Square ABS Deli Bowl / Insert

*Use alone, or as a dummy base for DB230-65 bowls*

230 x 230 x 45mm  
Black - **DB230S-BK**  
White - **DB230S-WH**



## Square Melamine Bowl

230 x 230 x 75mm

Black - **DB230-75-BK**  
Terracotta - **DB230-75-TC**  
White - **DB230-75-WH**

## Clear Lid

*Fits all DB230-75 bowls  
Easy to access product  
Reduce the amount of plastic wrapping*  
**DB230-CL**

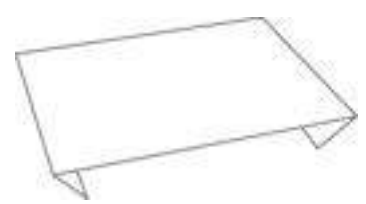

## Dummy Bases

*Reduce volume of food in display to still look full  
Can be made to fit all deli bowls  
Available in black, clear or white*



## Rectangular Melamine Bowl

345 x 230 x 75mm

Black - **DB345-75-BK**  
Terracotta - **DB345-75-TC**  
White - **DB345-75-WH**

## Clear Lid

*Fits all DB345-75 bowls  
Easy to access product  
Reduce the amount of plastic wrapping*  
**DB345-CL**

## Split Dummy Base with Divider

*Reduce volume of food in display to still look full*  
**DB345-DBD3**



DB345-75-BK Bowl

# Deli Platters & Plates

- Woodgrain, Marble, Grey Slate-Look & Black
- Perfect for serving or display
- Melamine

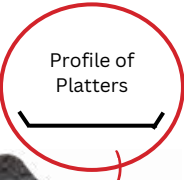

**Extra Small Deli Platter**  
200 x 130 x 25mm  
**DB20132B**

**Small Deli Platter**  
250 x 170 x 30mm  
**DB25173B**

**Medium Deli Platter**  
300 x 210 x 30mm  
**DB30213B**

**Large Deli Platter**  
340 x 240 x 30mm  
**DB34243B**

**Extra Large Deli Platter**  
390 x 270 x 30mm  
**DB39273B**

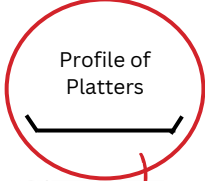

**Woodgrain-Look Melamine Deli Platter**  
300 x 160 x 17mm  
**DB30161T**



**Granite-Look Melamine Deli Platter**  
300 x 210 x 25mm  
**DB30203P**



**Marble-Look Melamine Deli Platter**  
300 x 210 x 25mm  
**DB30203M**

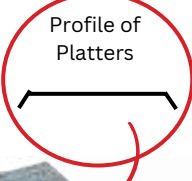

**Small Grey Slate-Look Melamine Deli Platter**  
300 x 160 x 17mm  
**DB30161S**

**Medium Grey Slate-Look Melamine Deli Platter**  
360 x 190 x 18mm  
**DB36191S**

**Large Grey Slate-Look Melamine Deli Platter**  
400 x 210 x 20mm  
**DB40211S**

## Deli Plates



**Round Melamine Display Plate/Riser**

- A. 300mm Ø (12") x 165mm H - **DB303016-W**
- B. 360mm Ø (14") x 165mm H - **DB303616-W**



# Deli - Poultry / Meat / Seafood ABS Tubs

- Lightweight ABS - No chipping or breaking.
- Strong and Unbreakable
- Sized to suit refrigeration units (all 240mm wide)
- Black (Std); (White or Woodgrain-Look made to order)

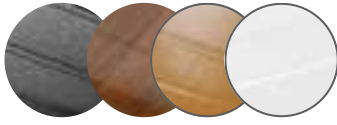

Refer to p.5 for more colour details

**Available on request  
Deli Bowls**  
240 x 240 x 40mm  
240 x 240 x 60mm

Uniform Width  
240mm

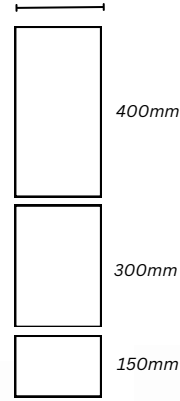

*Optimise your space  
and choose your  
own layout!*



## Rectangular ABS Deli Bowl

240 x 150 x 40mm  
Black - **DPT214-BK**  
White - **DPT214-WH**  
  
240 x 150 x 60mm  
Black - **DPT216-BK**  
White - **DPT216-WH**



## Rectangular ABS Deli Bowl

240 x 300 x 40mm  
Black - **DPT234-BK**  
White - **DPT234-WH**  
  
240 x 300 x 60mm  
Black - **DPT236-BK**  
White - **DPT236-WH**



## Long Narrow ABS Tub

240 x 400 x 40mm - Black - **DPT244-BK**  
240 x 400 x 60mm - Black - **DPT246-BK**

## Stackable Tub with Lid



## Medium Rectangular ABS Tub

400 x 300 x 60mm  
Black - **DPT43-B**



## ABS Lid for DPT43-B Tub

Enables stacking of tubs  
Black - **DPT43L-B**

## Deli Plates



**Round ABS Plate**  
240mm Ø x 20mm  
Black - **DP240-BK**  
White - **DP240-WH**

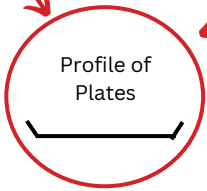

## Rectangular ABS Tray

300 x 240 x 25mm  
Black - **DP324-BK**  
White - **DP324-WH**

# Deli Displays Risers

- Each riser is made from one-piece of material, avoiding unsightly joins that could harbour bacteria
- Easy to keep clean
- Good ventilation to keep food cold
- 3 height levels
- Fit most refrigeration without modification
- Custom size requests are welcome

## Colours/Materials Available

- Black or White ABS
- Woodgrain-Look ABS
- Clear Acrylic
- Stainless Steel
- Black Powder-Coated Steel

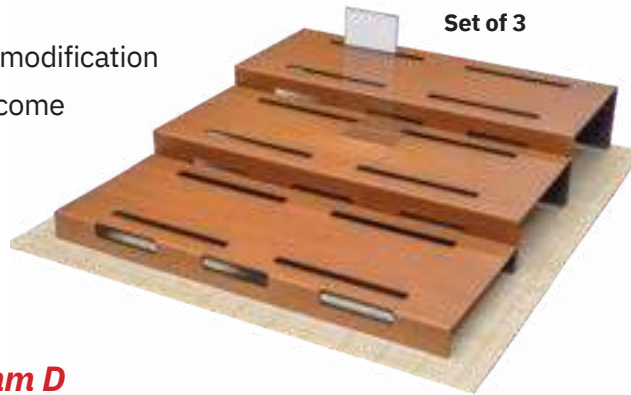

## Deli Riser Sets of 3 - 600mm Wide

- Riser heights: 40mm H, 80mm H & 120mm H
- Black - **DS3-600-B**
  - White - **DS3-600-W**
  - Clear - **DS3-600-C**
  - Woodgrain - **DS3-600-WG**
  - Stainless Steel - **DS3-600-SS**
  - Black Powder-Coat - **DS3-600-PCBK**

**All are 600mm W x 250mm D**



## Individual Tall Deli Risers

- 600 x 250 x 120mm H
- Black - **DS612-B**
  - White - **DS612-W**
  - Clear - **DS612-C**
  - Woodgrain - **DS612-WG**
  - Stainless Steel - **DS612-SS**
  - Black Powder-Coat - **DS612-PCBK**

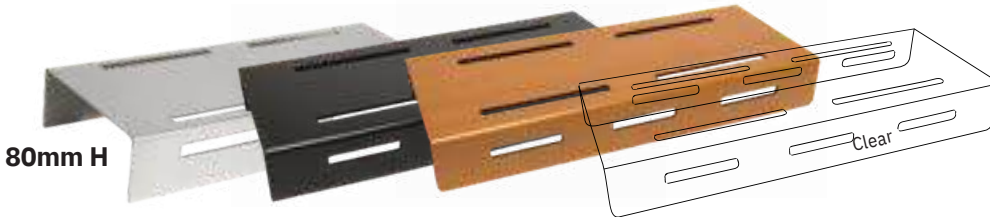

## Individual Medium Deli Risers

- 600 x 250 x 80mm H
- Black - **DS68-B**
  - White - **DS68-W**
  - Clear - **DS68-C**
  - Woodgrain - **DS68-WG**
  - Stainless Steel - **DS68-SS**
  - Black Powder-Coat - **DS68-PCBK**

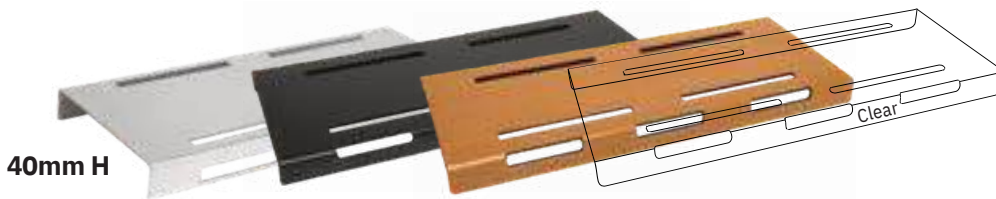

## Individual Low Deli Risers

- 600 x 250 x 40mm H
- Black - **DS64-B**
  - White - **DS64-W**
  - Clear - **DS64-C**
  - Woodgrain - **DS64-WG**
  - Stainless Steel - **DS64-SS**
  - Black Powder-Coat - **DS64-PCBK**

## Formed Deli Risers

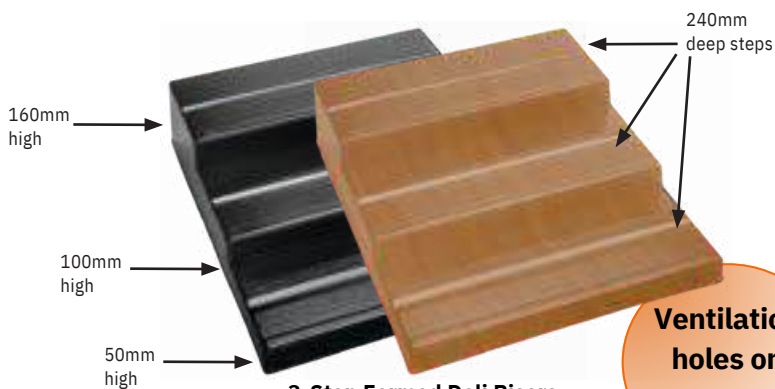

### 3-Step Formed Deli Risers

- 610 x 720 x 50 / 100 / 160 x 240mm H steps
- Black - **DS7616-B**
  - Woodgrain-Look - **DS7616-WG**

**Ventilation holes on request**

## Dark Woodgrain-Look Deli Risers:



### Deli Risers Set of 3 - 300mm Wide

- Riser heights - 40mm H, 80mm H & 120mm H
- Dark Woodgrain-Look - **DS3-300-DWG**

### Individual Deli Risers

- 300 x 250 x 120mm H - **DS3-312-DWG**
- 300 x 250 x 80mm H - **DS3-38-DWG**
- 300 x 250 x 40mm H - **DS3-34-DWG**

# Food Display Dividers

- Helps prevent cross contamination
- Made of one-piece of material, with no joints to gather bacteria
- Easy to wash
- Black & White (in ABS)
- Clear (Polycarb)
- Strong, will not break or chip



## Free-Standing Split-Foot Dividers

**400 x 100mm**

Black - **VDIV400-B**

White - **VDIV400-W**

Clear - **VDIV400-C**

**500 x 100mm**

Black - **VDIV500-B**

White - **VDIV500-W**

Clear - **VDIV500-C**

**600 x 100mm**

Black - **VDIV600-B**

White - **VDIV600-W**

Clear - **VDIV600-C**



## L-Foot Dividers

**400 x 100mm**

Black - **VDIV400L-B**

White - **VDIV400L-W**

Clear - **VDIV400L-C**

**500 x 100mm**

Black - **VDIV500L-B**

White - **VDIV500L-W**

Clear - **VDIV500L-C**

**600 x 100mm**

Black - **VDIV600L-B**

White - **VDIV600L-W**

Clear - **VDIV600L-C**



# Deli Accessories



**Stainless Steel Tongs with Coloured Grip**

245 x 40mm  
 Black - **FT240SS-BK**  
 Blue - **FT240SS-BLU**  
 Green - **FT240SS-G**  
 Red - **FT240SS-R**  
 Yellow - **FT240SS-Y**



**Polycarbonate Tongs**  
 240 x 40mm  
**FT240P-BK**



**Paring Knife & Pouch (with belt clip)**  
 200mm (100mm flexi blade)  
**VKS01**



**Long-Handle Serving Spoons**  
 Non-perforated - **SP387-W**  
 Perforated - **SP387S-W**



**Utensil Holder (tongs / scoops)**  
*Hang on baskets, crates, display stands, etc*  
 125 x 85 x 155mm  
**VUH2-B**  
**VUH2-W**



**Stainless Steel Scoop**  
 75 x 225 x 45mm  
**FS225-SS**



**Clear Scoop**  
 235mm  
**FS235-C**



**Artificial Boston Ivy**  
 152cm garland  
**Ivy-Boston**

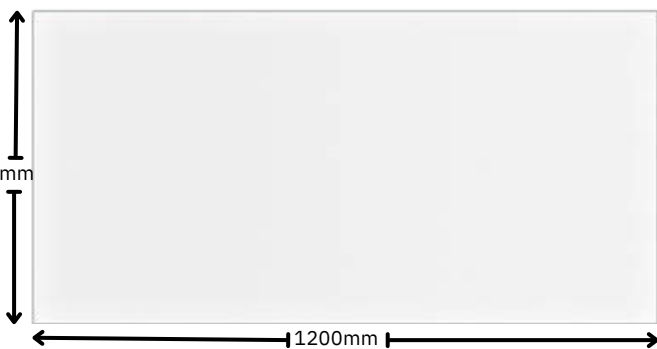

**Custom Sizes Available**

**Large Foodgrade Cutting Board**  
 1200 x 600 x 20mm  
**CB126-W**



**Stainless Steel Cutting Board Rack**  
*For drainage & separation of cutting boards*  
*Prevents bacteria & contamination*  
 270 x 170 x 230mm  
**CBR-SS**



**Artificial Fruit**  
 Grape Wine - **Grape-LW**  
 Grape Yellow - **Grape-LY**

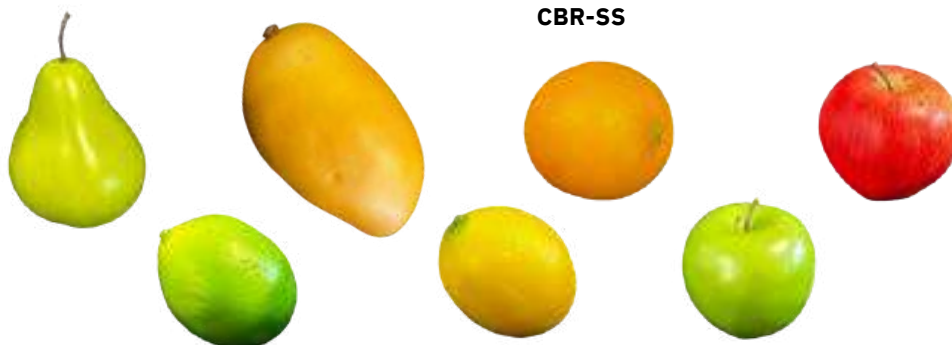

**Artificial Fruit**  
 Pear - **Pear-G**  
 Lime - **Lime-G**  
 Mango - **Mango-Y**  
 Lemon - **Lemon-Y**  
 Orange - **Orange-O**  
 Green Apple - **Apple-G**  
 Red Apple - **Apple-R**

# Cheese Displays

## Wooden & Polywicker



**Foodgrade Polywicker Tray**  
500 x 400 x 35mm  
**PWM54-N**



**Foodgrade Polywicker Mat**  
400 x 300 x 6mm  
**PWM43-N**



**Wooden Display Board**  
*For cheese & smallgoods*  
600 x 400 x 20mm  
**WDS64**

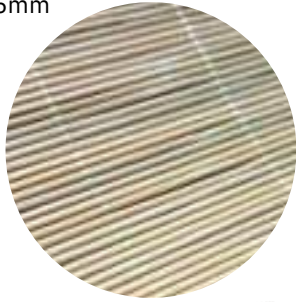

**Foodgrade Bamboo Matting**  
700 x 1240mm roll  
**Mat-BAM1247**



**Hessian / Jute roll**  
500 x 10m roll  
**Hess-10**

## Bamboo, Jute & Wood Wool



**Wood Wool - 3mm Shredded Pine**  
12kg bale - 600 x 400 x 700mm  
**WW13K**



**Non-Slip Matting Roll - 1200mm Wide**  
1200mm x 10m roll  
(can be cut to size)  
**Mat-NS1200-10-Beige**



**PWM43-N**  
**In Store**

# Clear-Fronted Tubs - for Refrigeration



- Create an eye-catching floating display
- Stagger the look using Half-Tubs at bay ends or a uniform look with all the same tubs
- Tubs are designed to fit 400mm deep & 500mm deep refrigeration shelving
- Tubs made from food grade ABS - won't break, chip, discolour or rust
- Tubs include drainage holes at the front to prevent moisture buildup
- Easy to clean - foodgrade material
- Clear-front panels are replaceable (all tubs except VT45CR),
- Available in Black (Std) or made to order - Woodgrain & Dark Woodgrain
- Designed to retrofit existing shelving easily, the tub hooks over the rear of the shelf

Can be customised to fit all fridges.

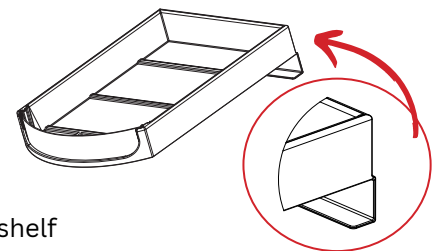

Easy to install - hooks onto existing shelving.

## Uniform-Look

9 x VT64C

Standard Bay 1220mm wide (4')

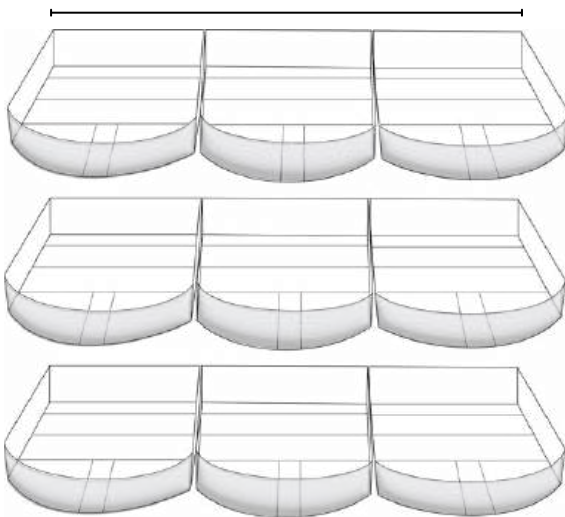

## Staggered-Look

7 x VT64C

2 x VT62-L & 2 x VT62-R

Standard Bay 1220mm wide (4')

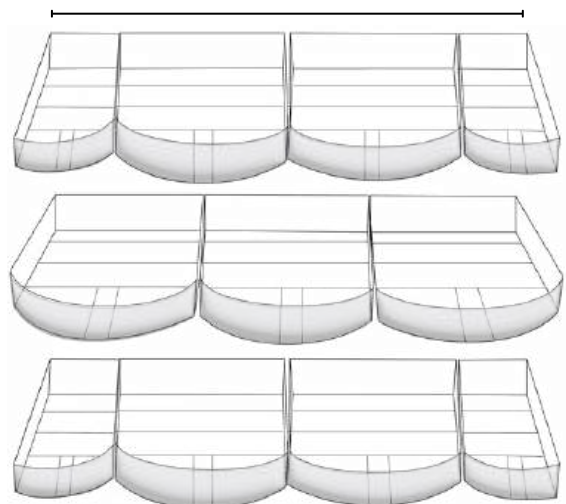

### Curved Clear-Front Tubs

400 x 600 x 75mm

Black - **VT64C-B**

Woodgrain-Look - **VT64C-WG**

Dark Woodgrain-Look - **VT64C-DWG**

(All dimensions in millimetres - width x depth x height)



### Curved Clear-Front Half-Tubs

200 x 600 x 75mm

Black - **VT62C-L-B / VT62C-R-B**

Woodgrain-Look - **VT62C-L-WG / VT62C-R-WG**

Dark Woodgrain-Look - **VT62C-L-DWG / VT62C-R-DWG**

# Clear-Fronted Tubs - for Refrigeration

All tubs fits Standard Bay 1220mm wide (4')



**Lid - Clear Polycarb**  
Fits VT64C tubs  
**VL64C**



**Tub Dividers**  
Fits VT64C tubs -  
360 x 560 x 70

*Custom sizes available on request*  
**VDIV64C**



**Curved Clear-Front Half-Tubs**  
200 x 600 x 75mm  
Black - **VT62C-L-B / VT62C-R-B**  
Woodgrain-Look - **VT62C-L-WG / VT62C-R-WG**  
Dark Woodgrain-Look - **VT62C-L-DWG / VT62C-R-DWG**

**Curved Clear-Front Tub**

*3 Per Shelf (Standard Bay)*

400 x 600 x 75mm

Black - **VT64C-B**

Woodgrain-Look - **VT64C-WG**

Dark Woodgrain-Look - **VT64C-DWG**



Three-Way Divider  
inside Tub VT66C

**NEW**

**Large Curved Clear-Front Tub**

*2 Per Shelf (Standard Bay)*

600 x 600 x 75mm

Black - **VT66C-B**

Woodgrain-Look - **VT66C-WG**

**Three-Way Divider**

*Fits VT66C Tubs*

*Does not fit VT66C pre Aug 2023*

600 x 600 x 75mm

**VDIV66C-3C**

**Large Volume Produce Tubs /  
Designed to fit on Bottom Refrigeration Shelf**



**NEW**

**Curved Clear-Front Tub - Large**

*3 Per Shelf (Standard Bay)*

*Curved clear fronted deep tub designed to go on the bottom shelf of a refrigeration unit*

400 x 500 x 100-200mm

Black - **VT452-VFC-B**



**Clear-Front Tub**

*4 Per Shelf (Standard Bay)*

*Fits 400mm refrigeration shelving*

400 x 300 x 70mm

Black - **VT43C-B**

Woodgrain-Look - **VT43C-WG**

Dark Woodgrain-Look - **VT43C-DWG**



**Clear-Front Tub**

*4 Per Shelf (Standard Bay)*

*Fits 500mm refrigeration shelving*

300 x 500 x 80mm

Black - **VT53C-B**

Woodgrain-Look - **VT53C-WG**

Dark Woodgrain-Look - **VT53C-DWG**



Custom size on request

**Fabricated Clear-Front Tub - Large**

*3 Per Shelf (Standard Bay)*

*Slant-Sided with a removable ramp  
Ramp is designed to minimise stock levels whilst always looking full*

400 x 500 x 150-200mm

Black - **VT45CR-B**

# ABS Tubs, Lids & Tub Dividers for Refrigeration



- Tubs have drainage holes as standard to prevent moisture buildup from misters, etc  
Should you prefer them without, speak to our sales team
- Black (Std). Woodgrain-Look and White made to order

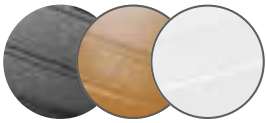

Refer to p.5 for more colour details



Cardboard box filled with dates

Standard Bay is 1220mm wide (4')

These Tubs are designed for **400mm deep shelving**



## Large Narrow Tub

*Fits 400mm deep refrigeration shelving*

610 x 405 x 75mm

Black - **VT6465R-B**

Woodgrain-Look - **VT6465R-WG**

White - **VT6465R-W**



**Dividers can be made to fit any tub**

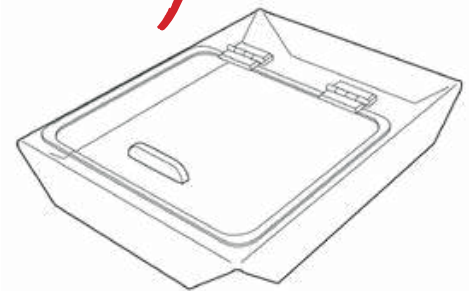

## Lid - Clear Polycarb

*Only fits cardboard boxes & VT4365R Tub*

280 x 370 x 60mm

**VLA43**



## Small Narrow Tub

*Fits 400mm deep refrigeration shelving*

155 x 405 x 70mm

Black - **VT4165R-B**

Woodgrain-Look - **VT4165R-WG**

White - **VT4165R-W**

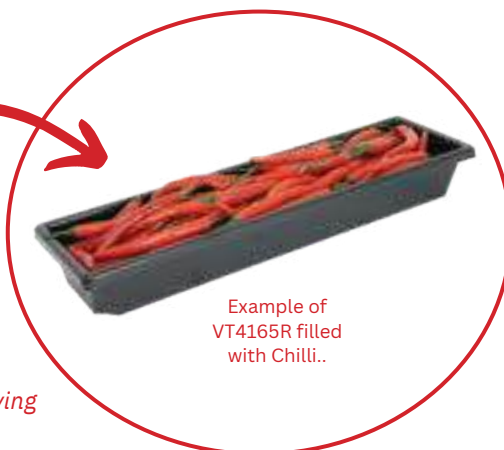

Example of VT4165R filled with Chilli..



## Small Tub

*Fits 400mm deep refrigeration shelving*

315 x 410 x 70mm

Black - **VT4365R-B**

Woodgrain-Look - **VT4365R-WG**

White - **VT4365R-W**



Standard Bay is 1220mm wide (4')

These Tubs are designed for **500mm deep shelving**



**Shallow Narrow Tub**

*Fits 500mm deep refrigeration shelving*

145 x 505 x 65mm

Black - **VT51665R-B**

Woodgrain-Look - **VT51665R-WG**

White - **VT51665R-W**



**Narrow Tub**

*Fits 500mm deep refrigeration shelving*

145 x 505 x 90mm

Black - **VT5169R-B**

Woodgrain-Look - **VT5169R-WG**

White - **VT5169R-W**



**Half-Sized Tub**

*Fits 500mm deep refrigeration shelving*

250 x 510 x 90mm

Black - **VT5239R-B**

Woodgrain-Look - **VT5239R-WG**

White - **VT5239R-W**

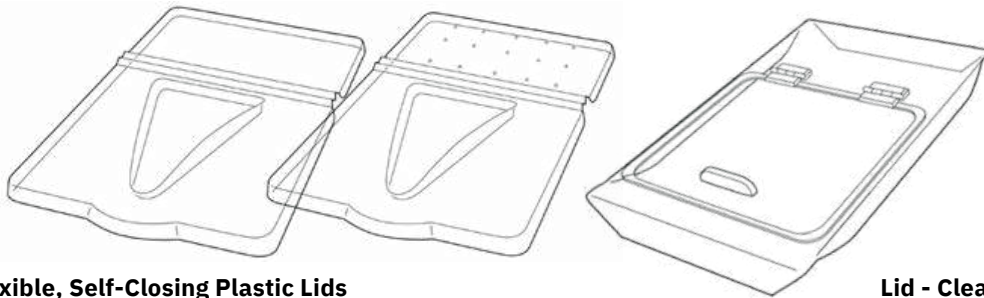

**Clear, Flexible, Self-Closing Plastic Lids**

*Fits VT537R & VT5395R Tubs*

315 x 515 x 30mm

Non-perforated - **VL539**

Perforated- **VL539P**

**Lid - Clear Polycarb**

*Fits VT537R & VT5395R Tubs*

285 x 525 x 30mm

**VLA53**



**Medium Shallow Tub**

*Fits 500mm deep refrigeration shelving*

310 x 510 x 70mm

Black - **VT537R-B**

Woodgrain-Look - **VT537R-WG**

White - **VT537R-W**



**Medium Tub**

*Fits 500mm deep refrigeration shelving*

*Hold 3kg salad leaves*

310 x 510 x 95mm

Black - **VT5395R-B**

Woodgrain-Look - **VT5395R-WG**

White - **VT5395R-W**



**Medium Deep Tub**

*Fits 500mm deep refrigeration shelving*

*Hold 5kg salad leaves*

310 x 510 x 140mm

Black - **VT5314R-B**

Woodgrain-Look - **VT5314R-WG**

White - **VT5314R-W**



**Large Shallow Tub**

*Fits 500mm deep refrigeration shelving - 3 per Bay*

410 x 510 x 70mm

Black - **VT547R-B**

Woodgrain-Look - **VT547R-WG**

White - **VT547R-W**



**Large Deep Tub**

*Fits 500mm deep refrigeration shelving - 3 per Bay*

410 x 510 x 120mm

Black - **VT5412R-B**

Woodgrain-Look - **VT5412R-WG**

White - **VT5412R-W**



**Large Tub**

*Fits 500mm deep refrigeration shelving & is best on the bottom shelf for large vegetables like Broccoli.*

800 x 460 x 80mm

Black - **VT8468R-B**

Woodgrain-Look - **VT8468R-WG**

White - **VT8468R-W**

# Refrigeration Ramps

- Increase viewing angle of tubs & trays for clear visibility of produce
- Standard Bay is 1220mm (4')

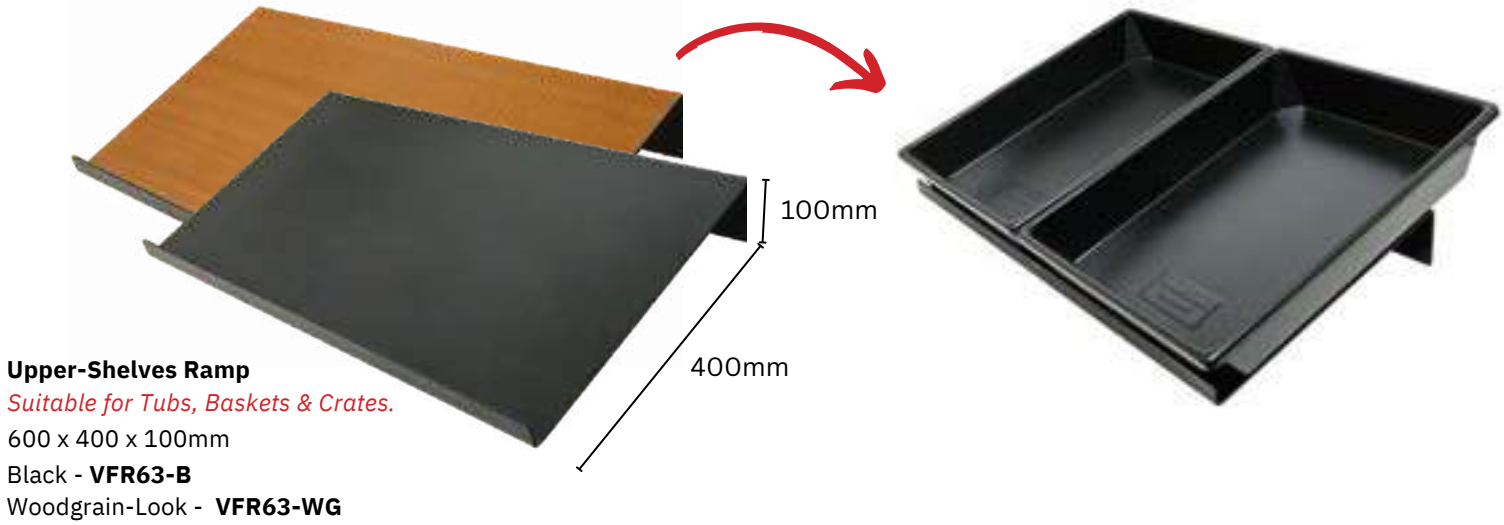

## Add Tubs with Polycarb lid



## Add Cardboard Boxes



# Stepped Refrigeration Trays for Punnets



- Designed in 600mm wide increments to suit both 1200mm & 1800mm wide bays. **(Standard Bay is 1220mm wide (4'))**
- Will fit 500mm/400m/300mm deep shelving
- Made from food grade ABS - Strong & lightweight
- Easy to clean
- Suitable for fridge or freezer
- Colours - Black (Std); White & Woodgrain-Look made to order



Refer to p.5 for more colour details

## For standard punnets



### Refrigeration Steps - 3 x 80mm Deep Steps

*2 per bay width  
Fits 300mm shelving  
Standard punnets*

600 W x 305 mm L

Black - **VTP6-300NS-B**

Woodgrain-Look - **VTP6-300NS-WG**

White - **VTP6-300NS-W**



### Refrigeration Steps - 4 x 80mm Deep Steps

*2 per bay width  
Fits 400mm shelving.  
Standard punnets*

600 W x 405 mm L

Black - **VTP6-400NS-B**

Woodgrain-Look - **VTP6-400NS-WG**

White - **VTP6-400NS-W**



### Refrigeration Steps - 5 x 80mm Deep Steps

*2 per bay width  
Fits 400mm shelving.  
Standard punnets*

600 W x 505 mm L

Black - **VTP6-500NS-B**

Woodgrain-Look - **VTP6-500NS-WG**

White - **VTP6-500NS-W**

## For large punnets



### Refrigeration Steps - 3 x 100mm Deep Steps

*2 per bay width  
Fits 400mm shelving, top shelf  
Large punnets or bags*

610 W x 390 mm L

Black - **VTP65-3-B**

Woodgrain-Look - **VTP65-3-WG**

White - **VTP65-3-W**



### Refrigeration Steps - 4 x 100mm Deep Steps

*2 per bay width  
Fits 500mm shelving, top shelf  
Large punnets or bags*

610 W x 510 mm L

Black - **VTP65-4-B**

Woodgrain-Look - **VTP65-4-WG**

White - **VTP65-4-W**



### Refrigeration Steps Risers

*Elevates the back of the stepped trays by 100mm, to increase visibility of produce. Has built-in, interlocking tabs to stabilise stepped trays & enable a continuous display.*

190 x 325 x 100mm

Black - **VTPR65-1.5-B**

White - **VTPR65-1.5-W**

(All dimensions in millimetres - width x depth x height)

# Cut Fruit Trays

## Refrigeration

- Suit 500mm deep shelving
- Washable foodgrade ABS
- Standard Bay is 1220mm wide (4')



**2-Trench Watermelon Tray**  
*Fits 2 per Shelf (Standard Bay)*  
615 x 495 x 110mm  
**VWM65-B**



**VWM65-B in store**



**VRM8 in store**



**4-Step Melon Tray**  
*With 8 contours for whole or cut melons.*  
*Fits 4 per Shelf (Standard Bay).*  
*It can be extended to fit produce bins,*  
*or modified for 400mm shelving*  
615 x 495 x 110mm  
**VRM8-B**

## Produce Bins



**3-Trench Curved Cut Fruit Tray**  
*For bananas or cut watermelon*  
450 x 800 x 50mm  
**VBW458-B**



**VBW458 in store**

# Salad Packs / Herbs / Hydroponics Displays

## Pre-Pack Display Trays and Racks

Standard Bay is 1220mm wide (4')

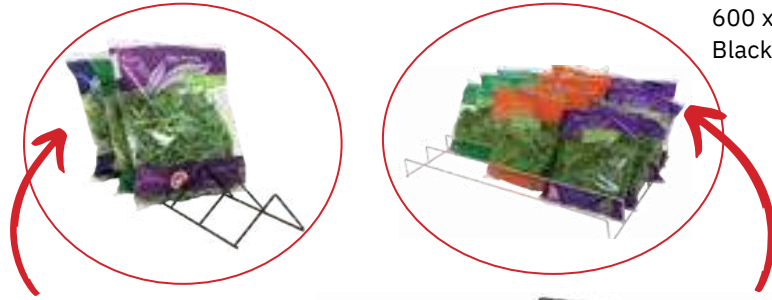

### Pre-Packaged Salad Wire Steps

2 per bay standard 1200mm bay

600 X 400mm x 90mm spacing

Black - **WR6-400-B**

600 x 500mm x 90mm spacing

Black - **WR6-500-B**

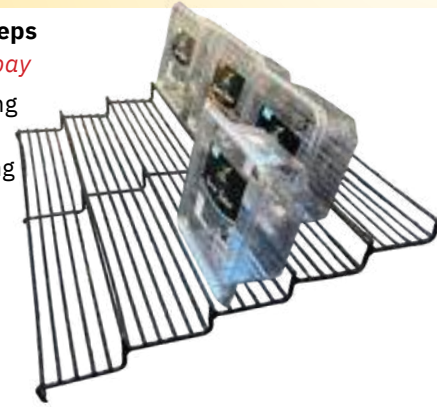

### 15-Slot Herb Packet Tray

370 x 410 x 50mm

**VHPT15-B**

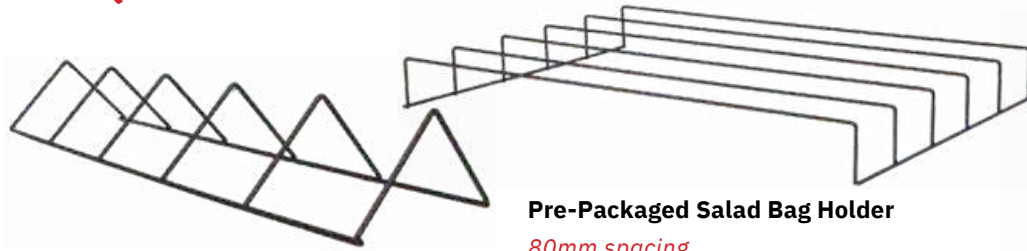

### Pre-Packaged Salad Bag Holder

80mm spacing

605 x 400 x 60mm

Black - **WR600-B**

Stainless Steel - **WR600-SS**

### Pre-Packaged Salad Bag Holder

75mm spacing

120 x 400 x 60mm

Black - **WR124-B**

## Hydroponics & Bunchline Displays

- Holds water to keep produce fresh
- Suitable for small-volume bunches of herbs like coriander, parsley & basil
- Wire-rack helps stand the produce upright



### Bunchline Tub with Support Rack

For asparagus, broccolini, fresh herb bunches  
2 x water wells

410 x 250 x 130mm (including rack)

**VBLT-B**



### Herb/Asparagus Tub & Rack

410 x 210 x 140mm

Black - **VHA4-B**

Woodgrain-Look - **VHA4-WG**

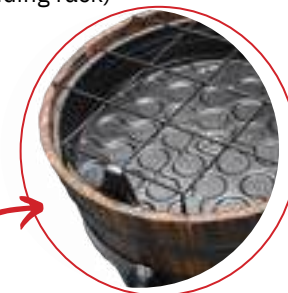

### Herb/Asparagus Barrel Stand

1 x wooden barrel,  
1 x Metal Barrel Stand,  
1 x water reservoir,  
1 x metal support rack,  
1 x A5 chalkboard & 1 x PoP clip

500mm Ø x 640mm

Dark Stain - **BAR500AB-DS**

Cherry Pine - **BAR500AB-CP**



### Herb/Hydroponics Multi-Channel Tub

2-Channel - 410 x 255 x 90 - **VMC2-300-B**

3-Channel - 410 x 375 x 90 - **VMC2-400-B**

4-Channel - 410 x 510 x 90 - **VMC2-500-B**

# Refrigerated Bunchline Displays

- Standard Bay is 1220mm wide (4')
- Adjustable angle
- Adjustable shelving

*Optimise display of large bunches of produce, celery, leeks, spinach etc.*

1200 X 145 X 1200mm  
VBL1200

Welded PVC A7  
waterproof ticket holder  
(with Velcro tabs)  
TPV02



Removable ramp.

Full bay - 1200mm wide

**Empty**

Brackets lock into refrigeration rear wall. Use to adjust angle of unit.

Peg hook holes added for hang-sell products like Herb Packet Trays

**NEW**

Adjustable shelving, in 100mm increments, to suit height of produce. Extra shelving available on request.

**Full**



# Hydro Tub

VBLT-600-B

**NEW**

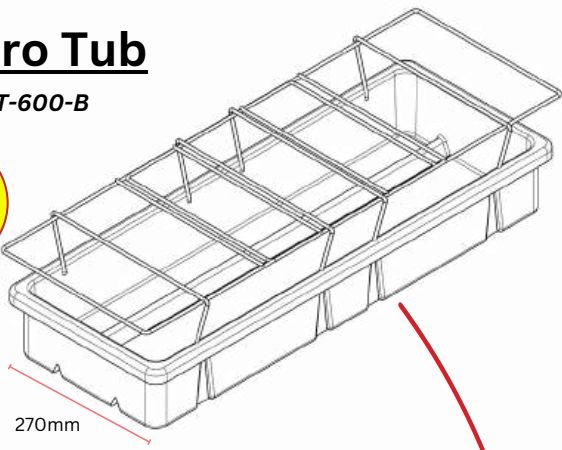

270mm



- Holds water to keep produce fresh.
- Suitable for small-volume bunches of herbs like coriander, parsley & basil.
- Wire-rack helps stand the produce upright.

## Adjustable shelving & different sizes available

Standard Bay is 1220mm wide (4')

1250mm

**NEW**

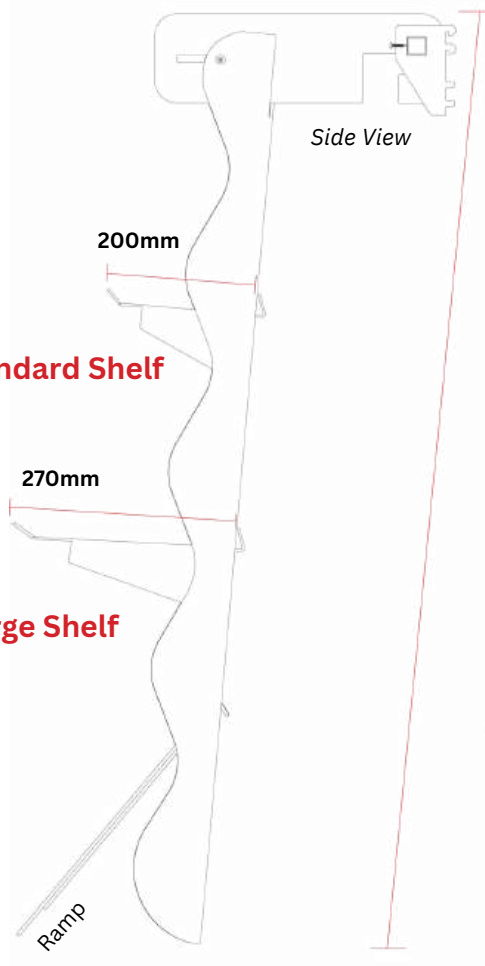

Standard Shelf

200mm

270mm

Large Shelf

Ramp

Side View

# Herb Packet Hooks

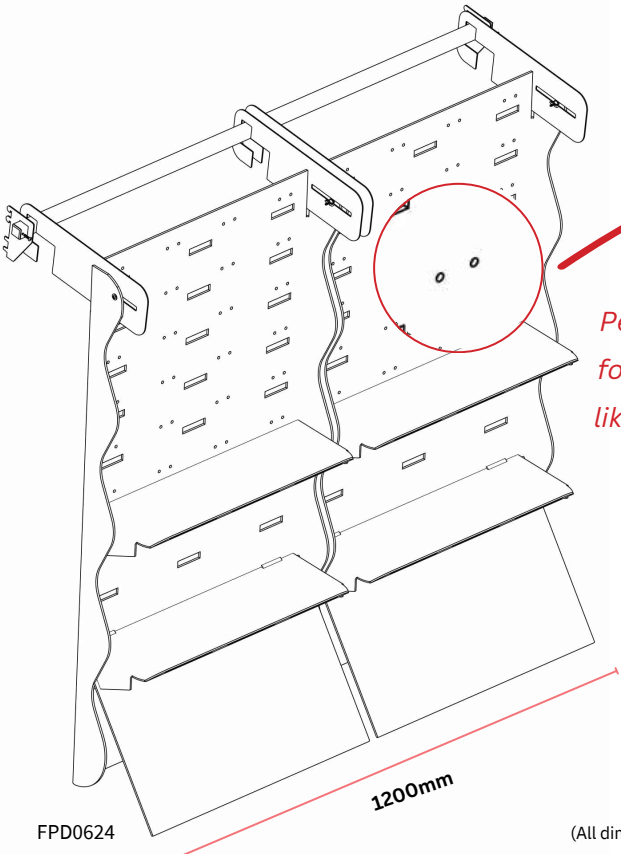

1200mm

Peg hook holes added for hang-sell products like Herb Packet Trays



FPD0624

(All dimensions in millimetres - width x depth x height)

# Ready Made Meal & Pre-Pack Meat Displays

- Designed to show face view of the product
- Stand meals up, vertical or horizontal
- Suitable for fridges & freezers
- Available in black, white and clear
- Australian made



**VPD7-B5 In Store**

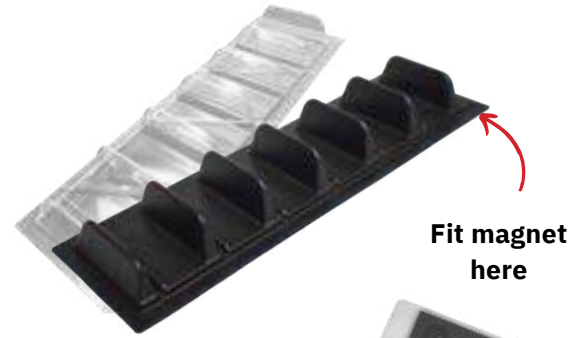

Fit magnet here

Request permanent personalised branding  
**VPD-BADGE**



Add optional magnet to the underside of the tray to hold it in place.  
**VPD-MAGNET**

**40mm spacing**



**Meal Tray - 7 x 40mm Spacing**

*40mm spacing for standard Ready Made Meals*

135 x 425 - 7 x 40mm Spacing

Black - **VPD7-B1**

Clear - **VPD7-C1**



**2 Wide Meal Tray - 7 x 40mm Spacing**

*40mm spacing for standard Ready Made Meals*

285 x 425 - 7 x 40mm Spacing

Black - **VPD7-B2**

Clear - **VPD7-C2**



**5 Wide Meal Tray - 7 x 40mm Spacing**

*40mm spacing for standard Ready Made Meals*

745 x 425 - 7 x 40mm Spacing

Black - **VPD7-B5**

Clear - **VPD7-C5**

**NEW**

**50mm spacing**



**Meal Tray - 6 x 50mm Spacing**

*50mm spacing for larger/deeper Ready Made Meals*

135 x 445 - 6 x 50mm Spacing

Black - **VPD6-B1**

Clear - **VPD6-C1**

**2 Wide Meal Tray - 6 x 50mm Spacing**

*50mm spacing for larger/deeper Ready Made Meals*

285 x 445 - 6 x 50mm Spacing

Black - **VPD6-B2**

Clear - **VPD6-C2**



**5 Wide Meal Tray - 6 x 50mm Spacing**

*50mm spacing for larger/deeper Ready Made Meals*

745 x 445 - 6 x 50mm Spacing

Black - **VPD6-B5**

Clear - **VPD6-C5**





**40mm spacing**

**50mm spacing**



**Pre-Packed Meal Steps - 6 x 40mm Spacing**

*40mm spacing for vac-sealed meat trays*

280 x 400 - 6 x 40mm spacing

Black - **VMDS245-B**

Clear - **VMDS245-C**

**Pre-Packed Meal Steps - 7 x 50mm Spacing**

*50mm spacing for bigger ready made meals*

400 x 500 - 7 x 50mm spacing

Black - **VMDS4050-B**

Clear - **VMDS4050-C**



*Has slot to lock front lip of container into the tray*



**VMDS245-B In Store**



**70mm spacing**

**Pre-Packed Meat Trays - 4 x 70mm Spacing**

*70mm spacing for bulk meat trays*

600 x 320 - 4 x 70mm steps

Black - **VMDS637-B**

White - **VMDS637-W**

# Refrigeration Roller Mats & Pushers



- Helps with facing up stock automatically, your range always look full
- Keeps items in place & tidy, especially odd-shaped items such as cylinders & bags
- Easy stock rotation, especially with rear access
- Simple to load stock

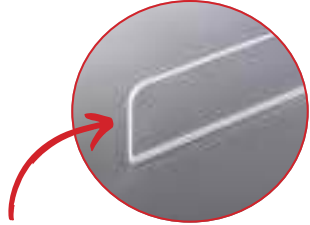

## Roller Mat - 4.5mm Roller

- 300 W x 400mm D - 4.5mm Roller - Black - **RM3040-B**
- 300 W x 570mm D - 4.5mm Roller - Black - **RM3057-B**
- 590 W x 400mm D - 4.5mm Roller - Black - **RM5940-B**
- 590 W x 570mm D - 4.5mm Roller - Black - **RM5957-B**

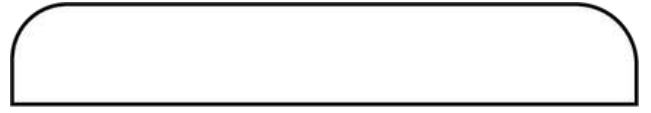

## Clear Acrylic Front - Roller Mat Stopper

- 300mm W - Clear - **RM30-C**
- 590mm W - Clear - **RM59-C**



## Back Wire Fence

- Stops product from falling off the back*
- 300mm W - Black - **RMBF30-B**
- 590mm W - Black - **RMBF59-B**

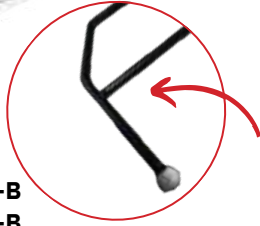

## Wire Dividers - 70mm Height

- 400mm L x 70mm - Stainless Steel - **RMWD40-SS**
- 570mm L x 70mm - Stainless Steel - **RMWD57-SS**

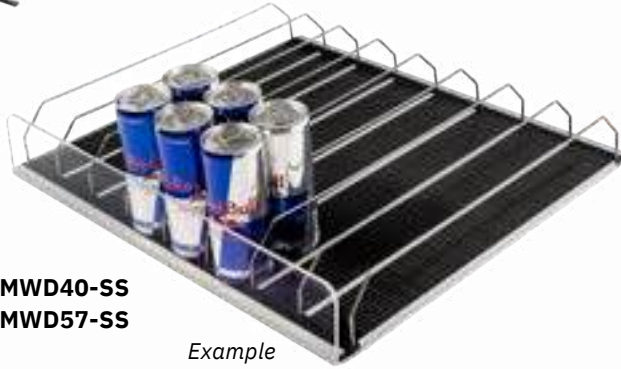

Example

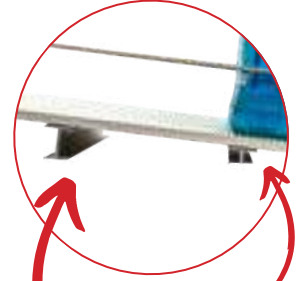

## Roller Mat Risers

*2 piece riser to suit 300mm & 590mm Roller Mats 25mm & 33m high*

- 300mm W Roller Mat - **RMRISER300**
- 590mm W Roller Mat - **RMRISER590**



Adjustable pushers, add front rail to shelf & then use locking button to move & lock into place

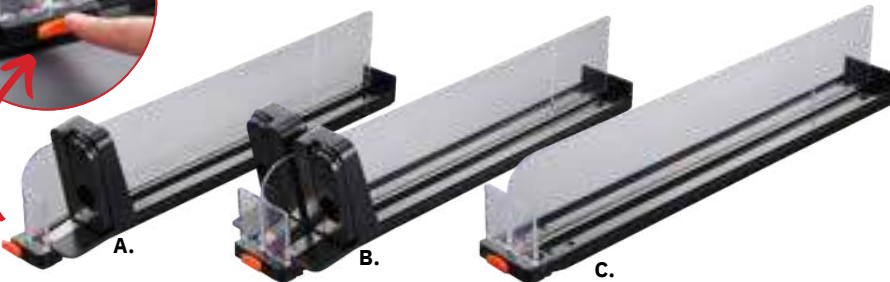

## A. Single Locking Pusher with Divider

- 384mm D - **PUSH384S-B**
- 474mm D - **PUSH474S-B**

## B. Double Locking Pusher with Divider

- 384mm D - **PUSH384D-B**
- 474mm D - **PUSH474D-B**

## C. Locking Divider - No Pusher

- 384mm D - **PUSH384N-B**
- 474mm D - **PUSH474N-B**

## Front Rail for Pushers

- 600mm L - **PUSHFR-B**



Adjustable swing out arms for larger packets



Example

# Bakery Displays

- Washable, foodgrade Polywicker baskets
- Liners available on request

## Trays & Mats



**Foodgrade Polywicker Tray**  
500 x 400 x 35mm  
**PWM54-N**



**Foodgrade Polywicker Mat**  
400 x 300 x 6mm  
**PWM43-N**



**Clear Lid for DPT4535 tray**  
**DPT4535-L**

Stackable serving  
Cake Tray & Lid



**Large Shallow Tray**  
450 x 352 x 25mm  
Black - **DPT4535-BK**  
White - **DPT4535-WH**

## Bakery Basket & Stand



A.

B.

### Round Polywicker Bakery Baskets

- A. No handles - 400mm Ø x 340mm - **PWB436R-N**  
B. With handles - 400mm Ø x 440mm - **PWB440R-N**

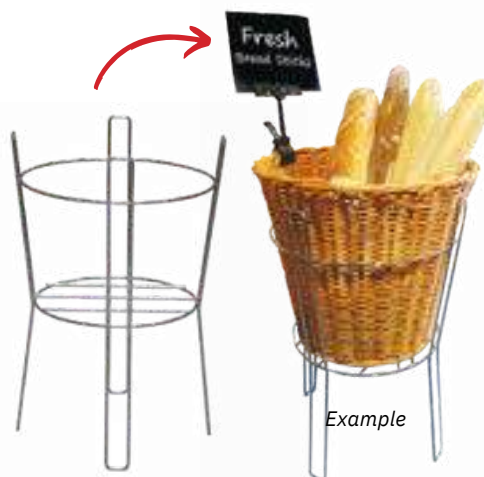

### Stainless Steel Basket Stand

*Holds PWB436R-N & PWB440R-N bakery baskets*  
390mm Ø x 580mm  
**PWBS-SS**



### Bakery Cabinet - Clear

*3 x slanted shelves, doors at rear*  
*Custom sized cabinets available on request*  
325 x 350 x 435mm  
**ABC-34**



### Stainless Steel Tongs with Coloured Grip

245 x 40mm  
Black - **FT240SS-BK**  
Blue - **FT240SS-BLU**  
Green - **FT240SS-G**  
Red - **FT240SS-R**  
Yellow - **FT240SS-Y**



### Polycarbonate Tongs

240 x 40mm  
**FT240P-BK**



### Utensil Holder (tongs / scoops)

*Hang on baskets, crates, display stands, etc*  
125 x 85 x 155mm  
**VUH2-B**  
**VUH2-W**



### Acrylic Chalkboard

75 x 105 x 3mm  
**ABB-A7**



### Pop Clip

Black - **TC25-B**  
Clear - **TC25-C**

*See pages 68 - 73 for more ticketing information*

# Versatile Display Cabinet - for Fresh Produce

- Add casters to make mobile
- More versatile than a standard produce bin
- Easily change the display to suit seasonal produce
- Put 2 units back-to-back, a half-circle unit at each end and create an instant island display
- Has in-built storage space behind a retractable door
- Select a pre-designed option, or customise your own



## VDC-Option-1

VDC - Option 1 with EVA fruit separators creates even fruit stacks on a soft base.



## VDC-Option-2

VDC-Option 2 with Polywicker baskets. Display product in the baskets with space at the front for other items



(pictured wooden crates are an optional extra)

Example Combination of VDC & VDCR

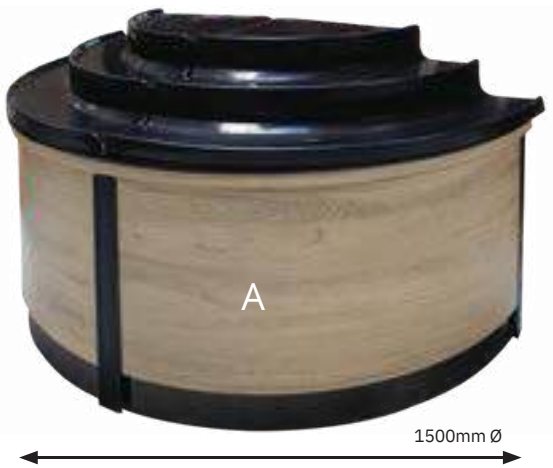

### Half-Circle Display Cabinet with Moulded Stepped Top

Use with 2 straight units, alone against a wall or 2 units back-to-back, to create a full circle

VDCR

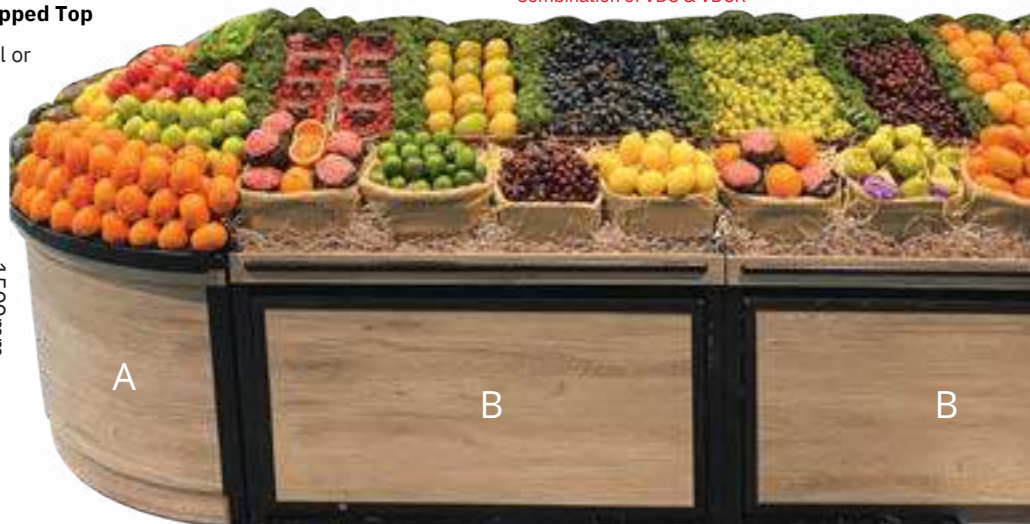
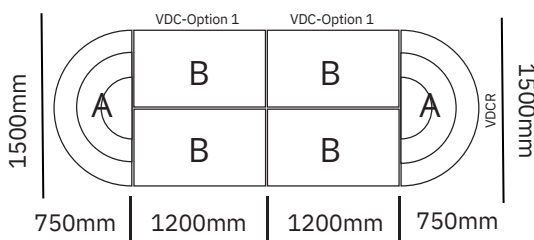

**VDC-Option-3**



**VDC-Option 3 with Wooden Crates & EVA Fruit Separators**  
 Display product in the crates with other fruit on the EVA Fruit Separators

**VDC ACCESSORIES:**

Liner available on request



**Satin Finished Wooden Crate**  
 560 x 370 x 110mm  
**WC53P-SP x 3**



**Stepped Tray - 150mm Steps**  
 595 x 790mm - **WBTS5-B**



**Stepped Tray - 120mm Steps**  
 595 x 790mm - **WBTS6-B**



**Stepped Tray - 95mm Steps**  
 595 x 790mm - **WBTS7-B**

**VDC-Option-4**



**VDC-Option4 with Display Steps & Hydroponics Tubs**  
 Display punnets or bagged produce, along with living or fresh cut herbs

(pictured wooden crates are an optional extra)



**Polywicker Basket**  
 290 x 450 x 95mm  
**PWB53-Earth x 1**



**Polywicker Basket**  
 400 x 500 x 95mm  
**PWB45-Earth x 2**



**Heavy-Duty Lockable Swivel Caster**  
 70mm rubber wheel  
**FPB-Caster70**



**Tub with Support-Rack**  
 For asparagus, broccolini, fresh herb bunches, 2 x water wells  
 410 x 250 x 130mm (including rack)  
**VBLT**



**Off-Set Bag Dispenser -**  
 Supplied with featured options  
 480mm high - **VBDS-C**  
 (alternative bag dispensers available on request)

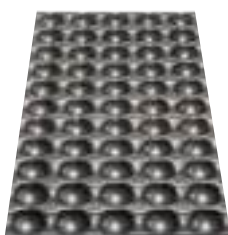

**Fruit Separator - 55 x 80mm Ø cups (EVA)**  
 900 x 410 x 40mm - **VF55D-EVA**  
 (rigid plastic Fruit Separators available on request)



**Large Wooden Crate - Dark Stain**  
 560 x 380 x 310 mm  
*Optional Extra*  
**WCC53-PDS**



**Clear DL Ticket Holder -**  
 Supplied with all options  
 215 x 23 x 115mm - **PTHDL**  
 (A6 & A7 size also available)

# Produce Bins



- Supplied flat-packed, with assembly instructions
- Custom sizes and finishes are available on request
- High legs, for ease of cleaning



**Produce Bin**  
900 x 900 x 900mm  
Dark Stain - **FPB900-DS**



**Produce Bin**  
900 x 900 x 900mm  
Jarrah laminate - **FPB900-JL**



**Produce Bin**  
900 x 900 x 900mm  
Black laminate - **FPB900-BL**



**Produce Bin**  
900 x 900 x 900mm  
Clear pine - **FPB900-CP**



**Produce Bin**  
900 x 900 x 900mm  
Ash laminate - **FPB900-AL**



**Half Circle Produce Bin**  
1500 x 750mm  
fitted with 2 x VQCS-1/4-B  
(featured on page 39)  
**VDCR**



**Example Combination:**

- 3 x FPB900-JL Bins
- 1 X VBT06 Bin Topper
- 1 x VSR2-B Straight Ramp
- 1 x VBT06-F-B Filler Ramp
- 1 x VCR-F-B Ramp Filler Strip
- 1 x VCR2-B Corner Ramp

# Bin Toppers (Moulded)

- Build a stunning fresh produce display
- Bin toppers are made of high-quality food grade ABS
- Easy to clean & swap for alternative seasonal displays
- Can be modified for various size bins
- Woodgrain-look is available on request

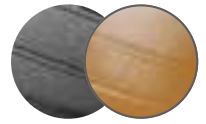

Refer to p.5 for more colour details

## 200mm High Series



**Corner Step**  
860 x 860 x 200mm  
**VBTO4-B**



**Straight Step**  
860 x 860 x 200mm  
**VBTO4S-B**

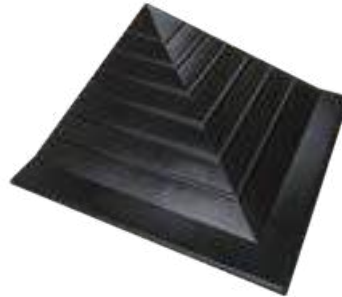

**Corner Ramp**  
860 x 860 x 200mm  
**VCR1-B**



**Straight Ramp**  
860 x 860 x 200mm  
**VSR1-B**

## 260mm High Series



**Corner Step**  
860 x 860 x 260mm  
**VBTO6-B**



**Straight Step**  
860 x 860 x 260mm  
**VBTO6S-B**

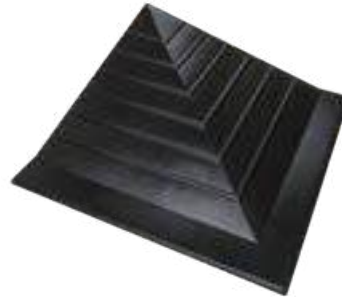

**Corner Ramp**  
860 x 860 x 260mm  
**VCR2-B**



**Straight Ramp**  
860 x 860 x 260mm  
**VSR2-B**

## 200mm High



**Pyramid Ramp - Full Bin Top**  
860 x 860 x 200mm  
*For displaying bagged produce on produce bins. For stand-alone bins.*  
**VBTO8-B**

## 260mm High



**Pyramid Step - Full Bin Top**  
860 x 860 x 260mm  
*For displaying punnets & pre-packs on produce bins. For stand-alone bins.*  
**VBTO3-B**



**Curved Corner Step**  
860 x 860 x 260mm  
*For displaying bananas, watermelon, pre-packed bags, etc*  
**VBTO7-B**



**Quarter-Circle Step**  
785 x 785 x 350mm  
*Fits two on VDCR*  
**VQCS-1/4-B**

### Example Combination:

- 4 x FPB900-DS Bins
- 4 x VBTO4-B Corner Steps - Bin Toppers
- 4 x VBTO4-F-B Stepped Filler Strips

### Ramp Filler Strip

60 x 840 x 40mm  
*For VCR1, VSR1, VCR2 & VSR2 ramps*  
**VCR-F-B**

### Stepped Filler Strips

60 x 860 x 80mm  
*Fill the gap between two produce bin toppers.*  
For VBTO4 steps - **VBTO4-F-B**  
For VBTO6 steps - **VBTO6-F-B**

FPD0624



(All dimensions in millimetres - width x depth x height)

# Produce Bin Barrel Display



Refer to p.5 for more colour details



**Corner Ramp with Barrel Cut-Out**  
860 x 860 x 260mm high  
*Holds BAR320-CP or BAR320-DS barrels*  
**VCR2-320B**



**Straight Ramp with Barrel Cut-Out**  
860 x 860 x 260mm high  
*Holds BAR320-CP or BAR320-DS barrels*  
**VSR2-320B**



**Example Combination:**

- 2 x FPB900-JL Bins
- 1 x VCR2-320B Corner Ramp w/ Barrel Cut-out
- 1 x VSR2-320B Straight Ramp w/ Barrel Cut-Out
- with 1 x VF35D-EVA Fruit Separator
- 1 x VCR-F-B Filler Strip
- 3 x BAR320-CP

## Custom Toppers - Made to Order



**Straight Steps - Fabricated**  
Customisable to size requirements



**Half-Pyramid Ramp - Fabricated**  
Customisable to size requirements



**Straight Ramp - Fabricated**  
Customisable to size requirements



**'Box-Gable' Ramp - Fabricated**  
Customisable to size requirements

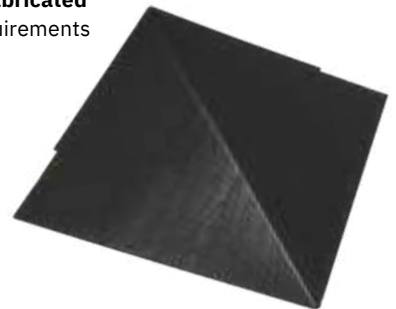

**Corner Ramp - Fabricated**  
Customisable to size requirements



# Stepped Bin Toppers

Designed to go on top of pre-existing ramps

- Perfect for punnets, pre-packed produce, nuts and loose produce
- The stepped toppers can be placed on existing ramps, or purchase our produce bin ramps separately
- Custom-sized requests are welcome
- See also Cut-Fruit Trays for bins on p.28

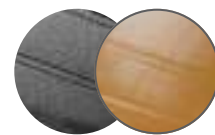

Refer to p.5 for more colour details

Combine and get a full display!



**Stepped Bin Topper -  
4 x 165mm Deep Steps**

450 W x 820 mm L

**VBTS4-B**

**VSR-EXT-C**  
Straight Ramp Extension

**PTHA7**  
PETG 13mm hook Ticketing

**WBTS6-B**  
5 x 160mm deep steps



**Stepped Bin Topper -  
5 x 160mm Deep Steps**

600 W x 790 mm L

**WBTS5-B**



**Stepped Bin Topper -  
6 x 130mm Deep Steps**

600 W x 790 mm L

**WBTS6-B**



**Stepped Bin Topper -  
7 x 110mm Deep Steps**

600 W x 790 mm L

**WBTS7-B**

## Ticketing / Brochure Holders (for Produce Bins & Cabinets) - Hanging

- Hangs over the end of produce bins or the front of cabinets
- Custom sizes available on request
- **20mm hook**

### Polycarb

- Clear folded ticket holders, to slip printed pricing tickets or signage into
- Rear fold to prevent sagging & corners catching
- Made from polycarbonate to last longer, more resistant & shatterproof

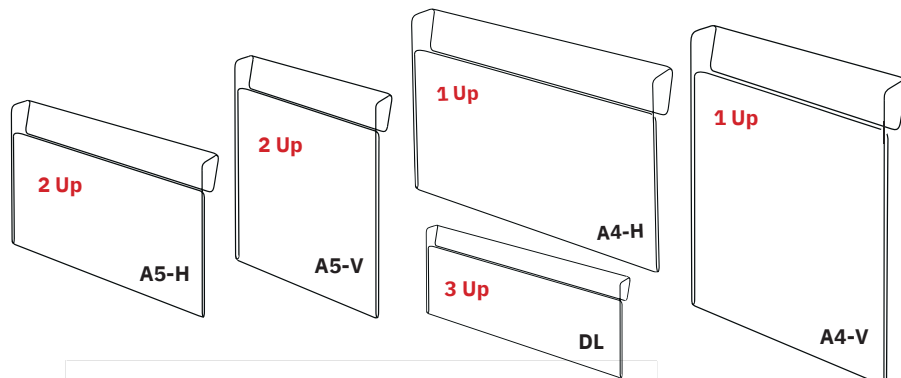

**A5 - Horizontal** - 215 x 157 x 20mm - **ABHA5-H**  
**A5 - Vertical** - 157 x 215 x 20mm - **ABHA5-V**  
**DL - Horizontal** - 215 x 105 x 20mm - **ABHDL**  
**A4 - Horizontal** - 300 x 215 x 20mm - **ABHA4-H**  
**A4 - Vertical** - 215 x 300 x 20mm - **ABHA4-V**

### Chalkboards

- Hook on the back allows these chalkboards to hang
- For hanging on the side of produce bins
- Matt/Gloss Acrylic chalkboards (see Page 69-73 for more)



**A5 - Vertical** - 157 x 215 x 20mm - **ACBHA5 - V**  
**A5 - Horizontal** - 215 x 157 x 20mm - **ACBAHA5 - H**  
**DL - Horizontal** - 215 x 105 x 20mm - **ACBHDL**  
**A4 - Vertical** - 215 x 300 x 20mm - **ACBHA4-V**  
**A4 - Horizontal** - 300 x 215 x 20mm - **ACBHA4-H**  
**750 x 405 x 20mm** - **ACBH47**  
**750 x 300 x 20mm** - **ACBH37**

**NEW**

# Bin Topper Extensions

The new clear-front Bin Topper Extensions are an innovative and versatile solution designed to enhance your produce storage and display capabilities

- **Optimised Space:** It offers an extension from the existing Bin Topper, allowing you to maximize the utilisation of your produce bins. The Bin Topper Extension goes to the outside dimensions of your produce bins (not just the inside), which allows more room for display products such as baskets and wooden crates.
- **Continuous Flow:** You can now create a seamless flow, making multiple produce bins, literally appear as one. This guarantees a smoother customer experience, facilitating efficient movement while shopping and ensuring a visually appealing display.
- **Clear Front Design:** Featuring a clear front that provides a modern and upmarket feel to your produce display area and enhances the visibility of your products, attracting customers and encouraging purchases.
- **Cost-Effective Revamp:** By investing in Bin Topper Extensions, you can transform your produce area without the expense of purchasing entirely new produce bins.

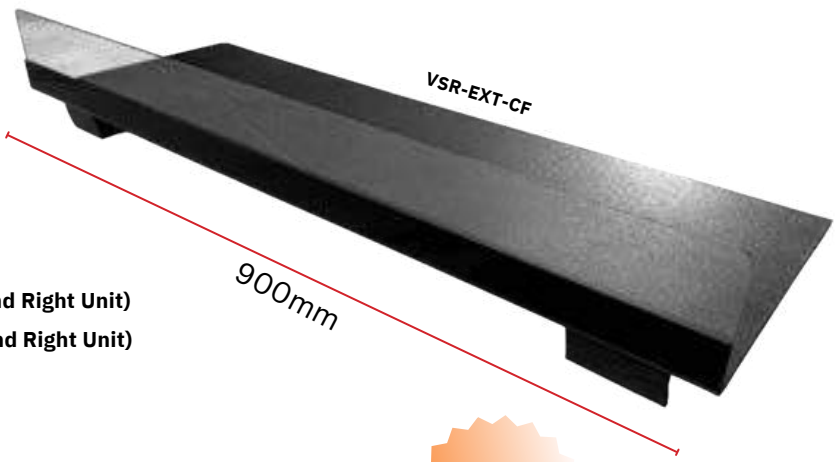

### Bin Topper Extension

900 x 200 x 100mm - Suit Straight Step - **VBT-EXT-CF**

900 x 320 x 100mm - Suit Straight Ramp - **VSR-EXT-CF**

### Corner Bin Topper Extension

900 x 200 x 100mm - Suit Corner Step - **VBTC-EXT-CF (Left and Right Unit)**

900 x 320 x 100mm - Suit Corner Ramp - **VCR-EXT-CF (Left and Right Unit)**

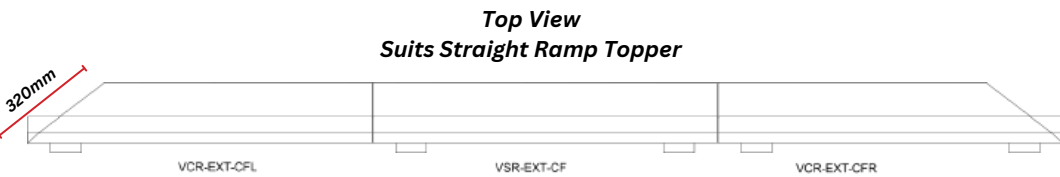
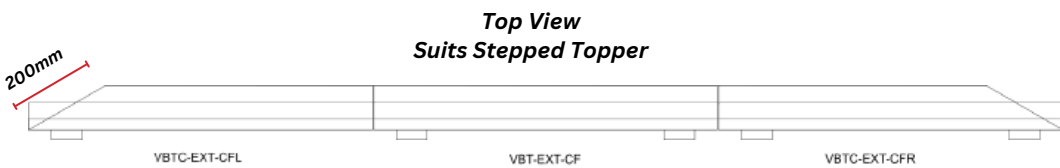

**ADD!**

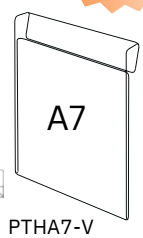

PETG 13mm hook Ticketing.  
*Hook over clear front*  
*For more details refer to p.71*

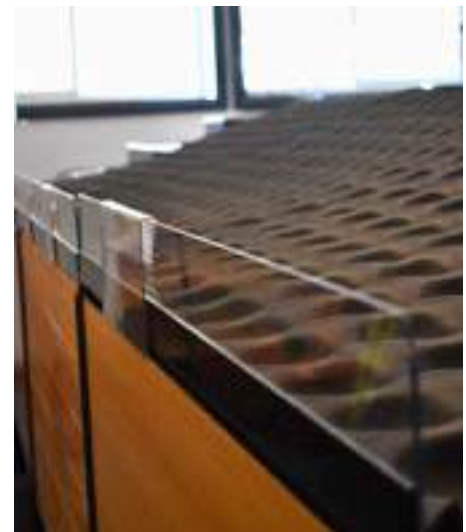
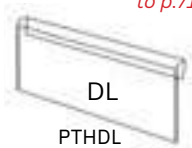

# Produce Bins Accessories



## Hanging Spill-Over Tub

460 x 280 x 85mm

*Rear hook of tub fits over side of produce bins*

**VTBH437**



## Spill-Over Crate Display 2 x WC053 + WC53P-SP



## Spill-Over Baskets for Produce Bins

870 x 200 x 100mm

Chocolate - **PWB82-CH**

Natural - **PWB82-N**



## Spill-Over Crates for Produce Bins

800 x 200 x 130mm

Dark Stain - **WC82-PDS**

Natural - **WC82-P**



## Trolley Bumper for Produce Bins

840 x 50 x 20mm

*Protect bins being damaged by trolleys*

**FPBTB-840**



## Heavy-Duty Lockable Swivel Caster

70mm rubber wheel

**FPB-Caster70**



## Basket / Wooden Crate Brackets

30 x 205 x 130mm,

With 25mm hook

*Set of 2*

*For Spill-over baskets & crates*

**FPB-BracketSet**

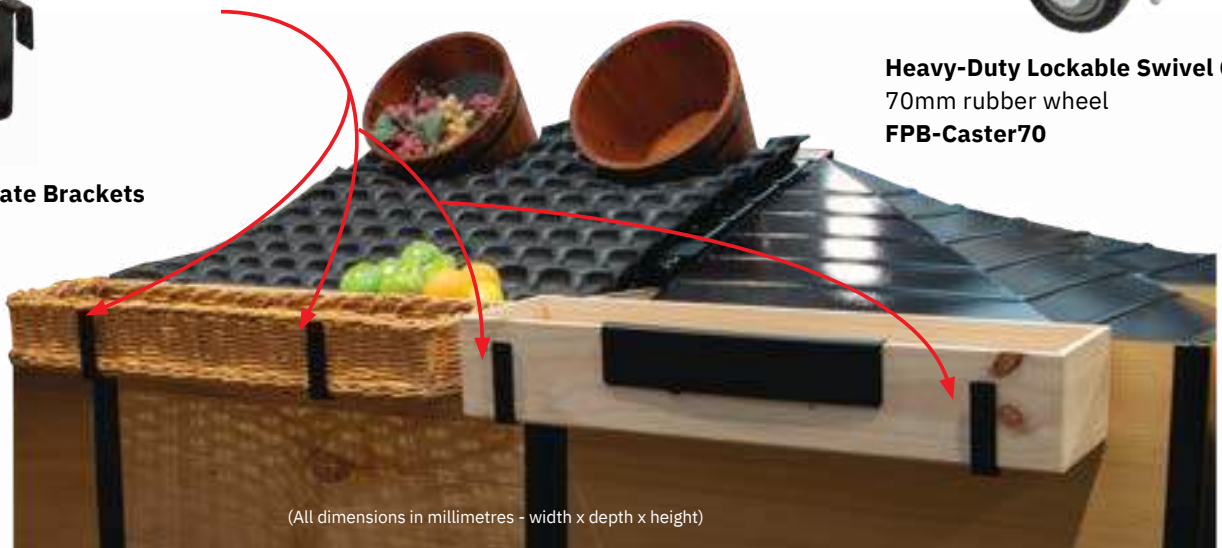

# Fruit Separators



***“One bad apple can spoil the lot”***

- Our EVA Fruit Separators, with their soft curved cup-edges, offer the best protection for your delicate fruit against bruising and denting, starting with your base layer
- Enable speedy set-up of great displays with minimal expertise
- Great displays encourage more sales
- They are washable & re-usable. A sustainable alternative to reduce landfill
- Soft EVA is easily cut to size, and interlocking multiple sheets together allows you to cover every bit of space
- Made of anti-bacterial EVA, it will not absorb water or go mouldy and will be long-lasting



*Competitor Trays after 1 week*



*EVA Fruit Separators after 1 year*

**Soft EVA Fruit Separators**

**NEW**



**Fruit Separator - Small - 65mm Ø Cups - Soft EVA**

Sheet size 390 x 820mm with **78 cups**  
*Designed for small seasonal stone fruit like apricots, plums, etc.*  
**VF78-EVA**

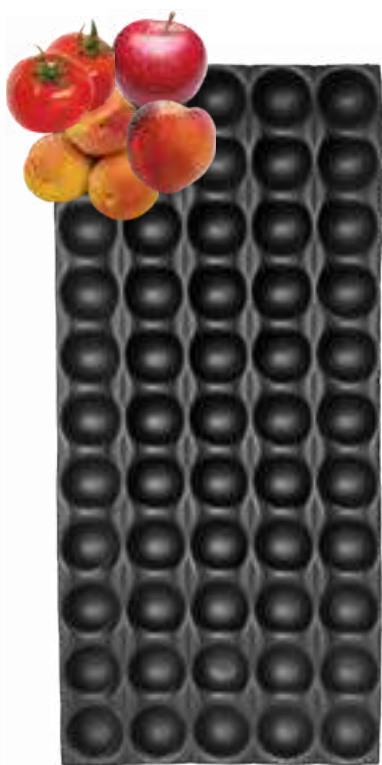

**Fruit Separator - Medium - 80mm Ø Cups - Soft EVA**

Sheet size 410 x 900 with **55 cups**  
*Designed for large soft fruit, apples, pears and tomatoes.*  
**VF55D-EVA**



**Fruit Separator - Medium - 80mm Ø Cups - Soft EVA**

Sheet size 900 x 900 with **121 cups**  
*Designed for large soft fruit, apples, pears and tomatoes.*  
**VF121D-EVA**

**NEW**



**Fruit Separator - Large - 90mm Ø Cups - Soft EVA**

Sheet size 440 x 800mm with **45 cups**  
*Designed for mangoes, grapefruit, large oranges.*  
**VF45D-EVA**



**Rigid ABS Fruit Separators**



**Fruit Separator - Medium - 80mm Ø Cups - Rigid ABS**

Sheet size 410 x 900 with **55 cups**  
*Designed for hard vegetables (potatoes/onions)*  
**VF55D-B**

# Matting

## Heavy GSM



**Non-Slip Matting Rolls - 400mm wide**  
400mm x 18m roll  
Heavy GSM Black - **Mat-NS400-BK**



**Non-Slip Matting Rolls - 600mm wide**  
600mm x 18m roll  
Heavy GSM Black - **Mat-NS600-BK**



**Non-Slip Matting Rolls - 1200mm wide**  
1200mm x 18m roll  
Heavy GSM Black - **Mat-NS1200-BK**

## Medium GSM



**Non-Slip Matting Rolls - 450mm wide**  
450mm x 18m roll  
Medium GSM Black - **Mat-NS4518-BK**  
Medium GSM Green - **Mat-NS4518-G**



**Non-Slip Matting Rolls - 900mm wide**  
900mm x 18m roll  
Medium GSM Black - **Mat-NS918-BK**  
Medium GSM Green - **Mat-NS918-G**



**Non-Slip Matting Rolls - 1200mm wide**  
1200mm x 10m roll  
*Natural colour, perfect base for cheese, good ventilation*  
Light GSM - **Mat-NS1200-10-Beige**

**Non-Slip**

**Cut to size  
available**



**Foodgrade Polywicker Tray**  
500 x 400 x 35mm  
**PWM54-N**



**Foodgrade Polywicker Mat**  
400 x 300 x 6mm  
**PWM43-N**



**Cheese / Small Goods Display Board**  
600 x 400 x 20mm  
**WDS64**



**Foodgrade Bamboo Matting**  
700 x 1240mm roll  
**Mat-BAM1247**



**Hessian / Jute roll**  
500 x 10m roll  
**Hess-10**

# Bag Dispensers

- Black and chrome
- Bag dispensers for standard rolls or StarSeal bags



## Top-mount StarSeal Bag Dispensers

28mm Ø bag roll spool

*430mm high, from mounting position - includes screws*

Black - **VBDTRS-BK**  
Chrome - **VBDTRS-C**



## Floor-Standing StarSeal Bag Dispensers

300 x 300 x 1065mm - 28mm Ø bag roll spool

*Heavy 4mm thick steel base*

Black - **VBDTR-FS-BK**  
Chrome - **VBDTR-FS-C**



## Top-mount Bag Dispensers

28mm Ø bag roll spool

*610mm high, from mounting position - includes screws*

Black - **VBDTR-BK**  
Chrome - **VBDTR-C**



## Corner-Mount Bag Dispensers

25mm Ø bag roll spindle

*440mm high, from mounting position - includes 100mm Ø disc & screws*

Black - **VBDC-PC-BK**  
Chrome - **VBDC-C**



## Optional Clear Acrylic Disc

182mm Ø x 6mm

*Optional large disc*

**VBDisc-A**

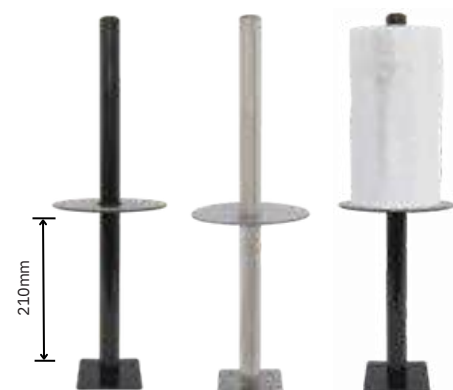

## Top-mount Bag Dispensers

25mm Ø bag roll spindle

*440mm high, from mounting position - includes 100mm Ø disc & screws*

Black - **VBDI-PC-BK**  
Chrome - **VBDI-C**



## Wall-Mount Bag Dispenser

290 x 130 x 40mm - 12mm Ø bag roll spool

**VBDH-PC-BK**

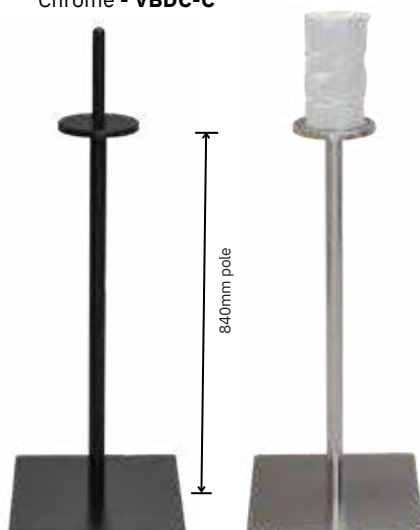

## Floor-Standing Single Head Bag Dispensers

300 x 300 x 1065mm - 25mm Ø bag roll spindle

*Heavy 4mm thick steel base*

Black - **VBD-FBK**  
Chrome - **VBD-FC**

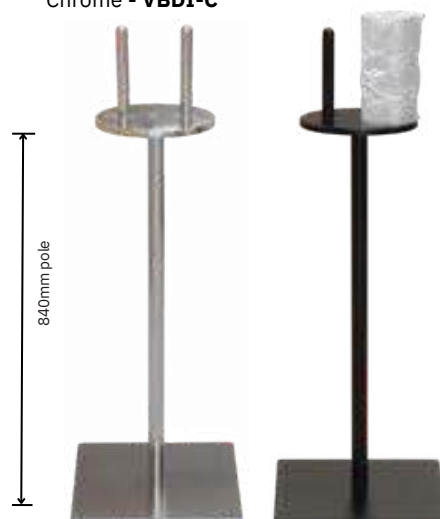

## Floor-Standing Double Head Bag Dispensers

300 x 300 x 1065mm - 25mm Ø bag roll spindle

*Heavy 4mm thick steel base*

Black - **VBD-DFBK**  
Chrome - **VBD-DFC**

(All dimensions in millimetres - width x depth x height)

# Mushroom Bag Holders & Bags



**Polycarb Mushroom Bag Holders - Clear**

300 x 40 x 100mm

*With 13mm rear hook*

**AMBH16**



**Suitable for Refrigeration**



**Coated Wire Mushroom Bag Holders**

240 x 65 x 220mm

*Vertical, with rear hanging hook*

Black - **WMBH20-B**

Stainless Steel - **WMBH20-SS**

## Mushroom Bag



**Printed Paper Mushroom Bag**

145 x 300mm

**PB-Mush**



**Cardboard Tray**

130 x 340 x 70 mm

**CT317**

## Bags



**Plastic**

*Not available for sale in WA and SA  
from 1st September 2024*



**Gusset Produce Bags - Standard**

350 x 450mm bags  
35mm Ø bag roll core  
*250 bags per roll*

**FVGB**

**Star Seal Produce Bags - Standard**

360 x 500mm bags  
35mm Ø bag roll core  
*250 bags per roll*

**FVSSB**

## **Compostable**



**Gusset Produce Bags - Compostable**

370 x 470mm bags  
35mm Ø bag roll core  
*250 bags per roll*

**Clear - FVCGB-CLR**



**Star Seal Produce Bags - Compostable**

370 x 470mm bags  
35mm Ø bag roll core  
*250 bags per roll*

**Clear - FVCSB-CLR**



# Mushroom Bay Display

## Refrigeration Steps Risers

190 x 325 x 100mm

Black - **VTPR65-1.5-B**

(Also available in white)



## Refrigeration Steps

600(w) x 405(d)mm

2 per bay width

Suits Standard Punnets

Black - **VTP6-400NS**

**Combine and get a full mushroom display!**



## Refrigeration Steps

610(w) x 390(d)mm

2 per bay width

Suits Large Punnets

Black - **VTP65-3-B**



## Refrigeration Steps

600(w) x 405(d)mm

2 per bay width

Suits Standard Punnets

Black - **VTP6-400NS**



## Refrigeration Steps

600(w) x 505(d)mm

2 per bay width

Suits Standard Punnets

Black - **VTP6-500NS**



## Polycarb Mushroom Bag Holders - Clear

300 x 50 x 160mm

**AMBH16**

FPD0624



## Bottom-Shelf Ramp - Clear Front

610 x 500 x 260mm

**VFR-6526-CF**



**Add some flags!**

# Basket Island Displays - Round

- Optional soft antibacterial EVA liners available on request
- Bases & Tops sold separately
- Foodgrade Polywicker



**Round Polywicker Top**  
450 Ø x 100mm  
Chocolate - **PWRT45-CH**  
Natural - **PWRT45-N**



**Round Polywicker Top**  
600 Ø x 150mm  
Chocolate - **PWRT60-CH**  
Natural - **PWRT60-N**



**Round Polywicker Top**  
900 Ø x 200mm  
Chocolate - **PWRT90-CH**  
Natural - **PWRT90-N**



580mm

**Round Polywicker Base & Top**  
450 Ø x 580mm  
Chocolate - **PWRB43-CH + PWRT45-CH**  
Natural - **PWRB43-N + PWRT45-N**



600mm

**Round Polywicker Base & Top**  
600 Ø x 600mm  
Chocolate - **PWRB58-CH + PWRT60-CH**  
Natural - **PWRB58-N + PWRT60-N**



630mm

**Round Polywicker Base & Top**  
900 Ø x 630mm  
Chocolate - **PWRB89-CH + PWRT90-CH**  
Natural - **PWRB89-N + PWRT90-N**

# Basket Island Displays - Square

- Optional soft antibacterial EVA liners available on request
- Bases & Tops sold separately

## Square Polywicker Top

750 x 750 x 150mm

Chocolate - **PWST75-CH**  
Natural - **PWST75-N**



## Square Polywicker Top

450 x 450 x 100mm

Chocolate - **PWST45-CH**  
Natural - **PWST45-N**

## Square Polywicker Top

600 x 600 x 160mm

Chocolate - **PWST60-CH**  
Natural - **PWST60-N**



## Square Polywicker Top

960 x 960 x 200mm

Chocolate - **PWST96-CH**  
Natural - **PWST96-N**

## Square Polywicker Base & Top

450 x 450 x 550mm

Chocolate - **PWSB43-CH + PWST45-CH**  
Natural - **PWSB43-N + PWST45-N**



## Square Polywicker Base & Top

600 x 600 x 610mm

Chocolate - **PWSB55-CH + PWST60-CH**  
Natural - **PWSB55-N + PWST60-N**

**Dividers available on request**



## Square Polywicker Base & Top

960 x 960 x 850mm

Chocolate - **PWSB90-CH + PWST96-CH**  
Natural - **PWSB90-N + PWST96-N**

(All dimensions in millimetres - width x depth x height)

# Foodgrade Polywicker Baskets



- Durable, washable foodgrade baskets
- **LINERS ARE AVAILABLE FOR ALL BASKETS - ON REQUEST**



## Round Polywicker Baskets

400mm Ø x 200mm  
Chocolate - **PWB400R-CH**  
Natural - **PWB400R-N**

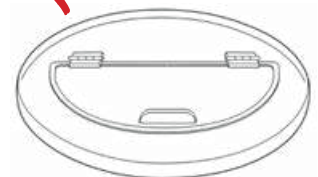

## Clear Polycarb Lid

410mm Ø x 30mm  
*For round 400mm Ø baskets*  
**VL400R**



## Oval Polywicker Baskets

580 x 390 x 200mm  
Chocolate - **PWB580-CH**  
Natural - **PWB580R-N**



**A.**



**B.**

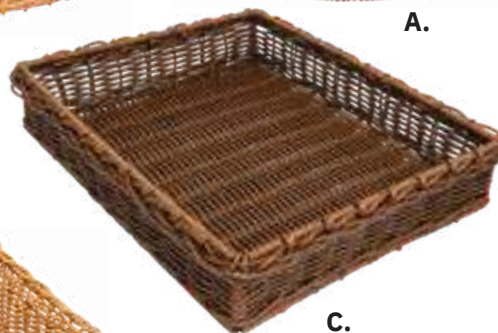

**C.**



**D.**

## Earth Polywicker Baskets

- A. Round - 400mm Ø x 95mm - **PWB400-Earth**
- B. Rectangular - 300 x 400 x 95mm - **PWB34-Earth**
- C. Rectangular - 400 x 500 x 95mm - **PWB45-Earth**
- D. Rectangular - 450 x 290 x 95mm - **PWB53-Earth**



## Slant-Sided Rectangular Polywicker Baskets

500 x 330 x 160-255mm  
Chocolate - **PWB500S-CH**  
Natural - **PWB500S-N**



## Oval Polywicker Shopping Baskets - with Handles

460 x 330 x 250mm  
Earth - **PWB460H-Earth**

*(Stand available to hold 6 baskets - refer to basket stands Pg 54)*



(All dimensions in millimetres - width x depth x height)



**Slant-Sided Rectangular Polywicker Baskets**

300 x 400 x 50-100mm  
Chocolate - **PWB34S-CH**  
Natural - **PWB34S-N**



**Slant-Sided Round Polywicker Baskets**

350mm Ø x 100-200mm  
Chocolate - **PWB35R-CH**  
Natural - **PWB35R-N**



**Rectangular Polywicker Baskets**

150 x 400 x 100mm  
Chocolate - **PWB41-CH**  
Natural - **PWB41-N**



**Rectangular Polywicker Baskets**

400 x 300 x 100mm  
Chocolate - **PWB43-CH**  
Natural - **PWB43-N**



Green & Black EVA, Frosted PPL liners  
for all baskets, on request.



**Slant-Sided Square Polywicker Baskets**

400 x 400 x 60-120mm  
Chocolate - **PWB44S-CH**  
Natural - **PWB44S-N**



**Rectangular Polywicker Baskets - with Hand Grips**

500 x 400 x 160mm  
Chocolate - **PWB54-CH**  
Natural - **PWB54-N**



**Rectangular Polywicker Baskets**

600 x 400 x 100mm  
Chocolate - **PWB64-CH**  
Natural - **PWB64-N**



**Long Rectangular Polywicker Baskets**

870 x 200 x 100mm  
Chocolate - **PWB82-CH**  
Natural - **PWB82-N**

# Basket & Stand Sets

- Washable, foodgrade baskets (soft antibacterial EVA liners available as optional extras)
- Heavy-duty lockable wheels
- Perfect for “off-location“ display“ display
- **Improved design** for optimum display



**Oval Basket & Stand Sets - 2-Tier & 3-Tier**

580 x 500 x 1100mm

2-Tier - Chocolate - **PWB20-CH**  
2-Tier - Natural - **PWB20-N**

3-Tier - Chocolate - **PWB30-CH**  
3-Tier - Natural - **PWB30-N**

**Round Basket & Stand Sets - 2-Tier & 3-Tier**

500 x 500 x 1100mm

2-Tier - Chocolate - **PWB2R-CH**  
2-Tier - Natural - **PWB2R-N**

3-Tier - Chocolate - **PWB3R-CH**  
3-Tier - Natural - **PWB3R-N**



**Slant-Sided Rectangular Basket & Stand Sets - 2-Tier & 3-Tier**

500 x 500 x 1100mm

2-Tier - Chocolate - **PWB2S-CH**  
2-Tier - Natural - **PWB2S-N**

3-Tier - Chocolate - **PWB3S-CH**  
3-Tier - Natural - **PWB3S-N**



Add THA4 - A double-sided A4 sized ticket holder with a clamp that can easily attach to metal bars, wooden boxes and much more.  
Refer to P. 68

## Bakery Baskets & Stand



A.

B.

**Round Bakery Baskets**

A. No handles - 400mm Ø x 340mm - **WB436R-N**  
B. With handles - 400mm Ø x 440mm - **WB440R-N**

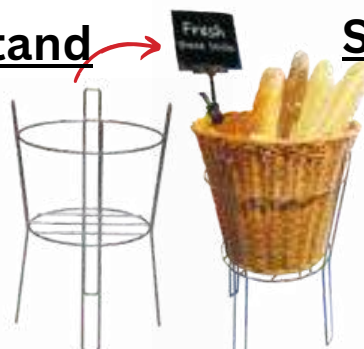

**Stainless Steel Basket Stand**

Holds **PWB436R-N** & **PWB440R-N** bakery baskets

390mm Ø x 580mm

**PWBS-SS**

## Shopping Basket & Stand Set

**Shopping Basket Stand & Baskets**

With lockable wheels

500 x 500 x 850mm

Earth - **PWB20-E**  
(includes 6 x **PWB460H-E** baskets - refer Pg 52)



# Produce Carton Stand

- Designed to hold full produce cartons
- Mobile display stands are great for island & end-of-aisle displays, impulse buys, point of purchase and cross-merchandising.
- Stands are made from black powder-coated steel
- Heavy duty Lockable wheels
- Crates are made from Australian stain-finished premium wood - natural or stained (see page 60)
- Foodgrade liners available
- Overall 30kg weight capacity

## 3 - Tier Large Stand Set

500 x 675 x 1100mm

*Stand with specially designed hoops, to hold large wooden crates or large cardboard fruit boxes*

**Stand-5040**



Stand 5040 -In store image

With the new support bracket the stand can now hold over 10kg per tier

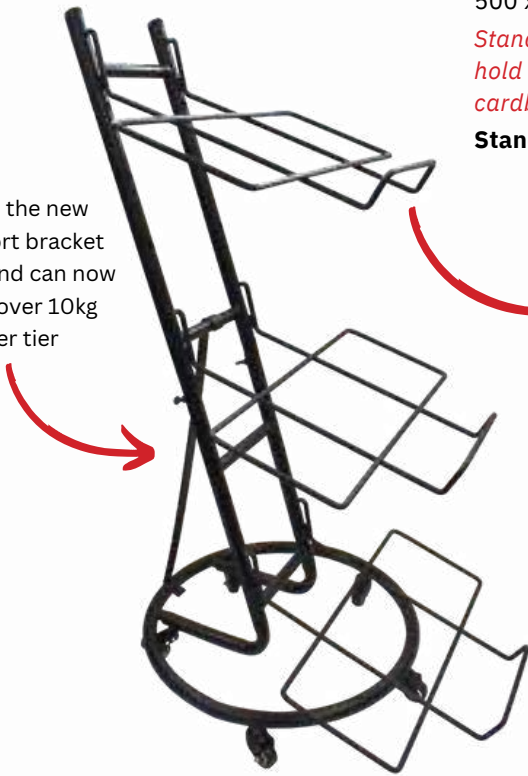

Metal Hoop  
**Hoop5040**



Our 3-tier stand is perfect for displaying your pre-filled fruit boxes with delicate stone fruit.

You don't need to handle the produce! Less bruising and shrinkage.

Mobile stand so you can position close to hot spots in-store to maximise sales

**Add wooden crates & liners!**

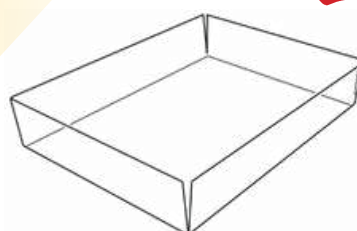

**Polypropylene Liner - Frosted**

*Fits WC54-P wooden crate*

**WC54-PPL**



**3-Tier Large Wooden Crate Stand Set**

500 x 675 x 1100mm

*Pictured with 3 x crates*

**Natural - WC3S54-P**

# Mobile Wooden Crate & Stands Sets

## 4-Tier Slat-Sided Crate & Stand Set

500 x 500 x 1100mm



Dark Stain - **WC4F-PDS**



Natural - **WC4F-P**



Metal Hoop  
Hoop4535



Add THA4 - A double-sided A4 sized ticket holder with a clamp that can easily attach to metal bars, wooden boxes and much more. Refer to Page. 68



WC3F-P in store

## 3-Tier Slat-Sided Crate & Stand Set

500 x 500 x 1100mm



Dark Stain - **WC3F-PDS**



Natural - **WC3F-P**

## 2-Tier Slat-Sided Crate Stand Set

500 x 500 x 1100mm



Dark Stain - **WC2F-PDS**



Natural - **WC2F-P**

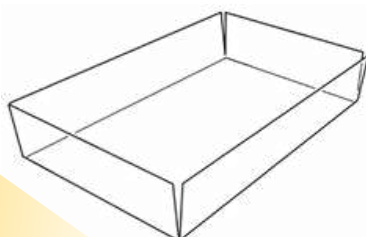

**Polypropylene Liner - Frosted**  
Fits WTH53-P wooden crate  
**WTH53-PPL**

Add liners to your crates! Easy to maintain clean displays.



Add a VBLT to crate a Hydroponic Mobile Stand!  
See page 29



## 3-Tier Slant-Sided Crate & Stand Set

500 x 500 x 1100mm



White-Wash - **WC3S-WW**

Dark Stain - **WC3S-PDS**

Natural - **WC3S-P**

Black - **WC3S-BK**

Aged - **WC3S-Aged**

## 2-Tier Slant-Sided Crate & Stand Set

500 x 500 x 1100mm



White-Wash - **WC2S-WW**

Dark Stain - **WC2S-PDS**

Natural - **WC2S-P**

Black - **WC2S-BK**

Aged - **WC2S-Aged**

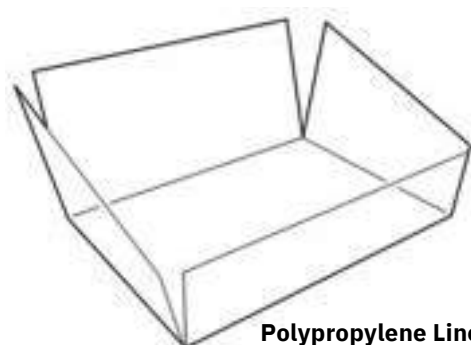

**Polypropylene Liner - Frosted**

*Fits WCS53-P wooden crate*

**WCS53-PPL**

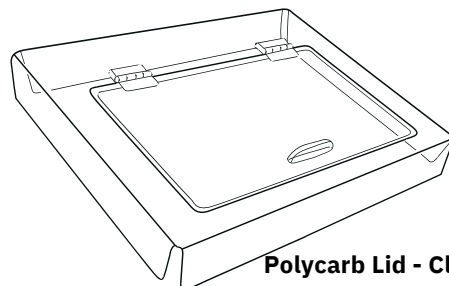

**Polycarb Lid - Clear**

*Fits WCS53 crates, to prevent contamination and keep products fresh.*

**505 x 405 x 35mm - VLS53**

**Utensil Holder & Tongs**



*(See page 57 for more details)*

Add liners and lids to your crates! Easy to maintain clean displays.

# Wooden Floor Stands - Free Standing

- Australian made, dried kiln wood



Black - **WS4-PBK**



Dark Stain - **WS4-PDS**



Natural - **WS4-P**



**Rustic 4-Tier Staggered Shelf Stand**

460 x 450 x 1380mm

*Supplied flat-packed, with assembly instructions*

*Logo stencil on request*

**WS134-Rustic**

**4-Tier Premium Wooden Stand, with optional shelf angle level or slanted (485 x 390 x 1200mm) with:**

- 1 x fixed crate (bottom) - level
- 3 x adjustably crates (level or slanted at 33° degrees)
- Internal crate dimension 420 x 370 x 65mm

*Supplied flat-packed (with simple assembly instructions)*

Polypropylene Liner Available- Frosted (optional extra)

**WS4-PPL**

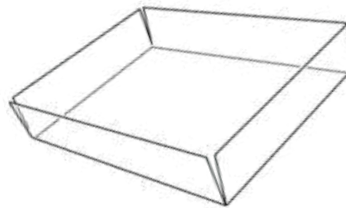

**Wooden Cart with Blackboard Header**

600 x 1300 x 1230mm

*Supplied flat-packed, with assembly instructions*

**WCART**

**5-Tier Premium Wooden Shelf Display with Chalkboard Header**

760 x 385 x 1500mm

*Supplied assembled with the chalkboard header detached*

Natural - **WS5-5**



**3-Tier Wooden Block Riser Set**

900 x 900 x 750mm

*Also available in Dark Stain  
Blocks can be purchased individually (see next page)*

Natural - **WP963-P**



## Wooden Floor Stands



**Small Block Riser**  
300 x 300 x 220mm  
Natural - **WP33-N**  
Dark Stain - **WP33-PDS**



**Medium Block Riser**  
600 x 600 x 235mm  
Natural - **WP66-N**  
Dark Stain - **WP66-PDS**



**Large Block Riser**  
900 x 900 x 250mm  
Natural - **WP99-N**  
Dark Stain - **WP99-PDS**



**2-Shelf Rustic Wooden Display Hutch**  
*Supplied fully assembled*  
1120 x 370 x 1070mm  
Natural - **WDH131**

## Wooden Counter-Top Stands

- Australian Made
- Custom display stands enquires welcome



**Rustic Wooden Counter Display - 4-Tier**  
500 x 340 x 435mm  
Natural - **WCTD-444**



**Wooden Counter Display - 2-Tier**  
425 x 380 x 360mm  
Natural - **WCTD-443**  
Dark Stain - **WCTD-443-PDS**  
Black - **WCTD-443-BK**



**Blackboard for WCTD**  
370 x 12 x 80mm  
*Custom sizes available on request*  
**ABB443**

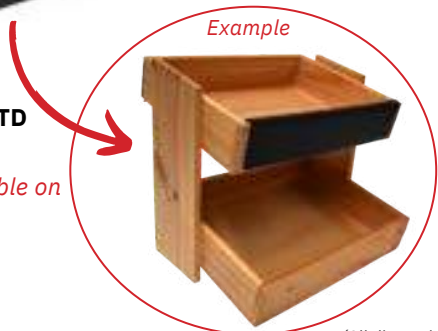

*Example*

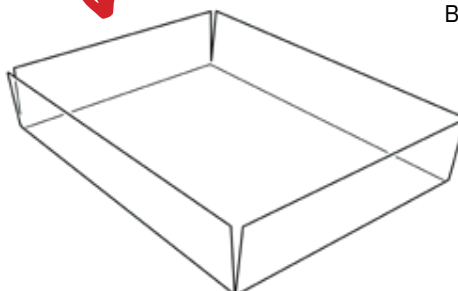

**Polypropylene Lining - Frosted**  
*(fits inside WCTD-443 tray)*  
**WCTD443-PPL**



Available in:  
Natural,  
Dark Stain  
& Black

WCTD-443 In-Store

# Wooden Crates

## Stencilling & Laser Etching

- Personalise standard or custom-sized wooden crates
- Your brand can be Stencilled in various colours or Laser Engraved
- Organic produce is a rapidly growing market in Australia and worldwide
- Make your organic section stand out using Stencilling or Laser Engraving.



## Wooden Crates

- Use in cabinets, on produce bins, or incorporate in our Mobile Stand Sets
- Made with a premium satin finish, assorted colours & styles
- Other colour and custom size requests are always welcome
- Protect your crates by lining them with our durable, washable, **foodgrade liners**
- Australian Made

### Wooden Crate - Premium Finish

400 x 300 x 95mm



**WC43-Aged**  
Aged

**WC43-P**  
Premium

**WC43-PDS**  
Dark Stain

**WC43-PBK**  
Black

**WC43-PWW**  
White-Wash

### Wooden Crate - Premium Finish

500 x 400 x 95mm



**WC54-Aged**  
Aged

**WC54-P**  
Premium

**WC54-PDS**  
Dark Stain

**WC54-PBK**  
Black

**WC54-PWW**  
White-Wash

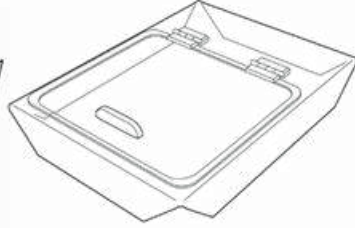
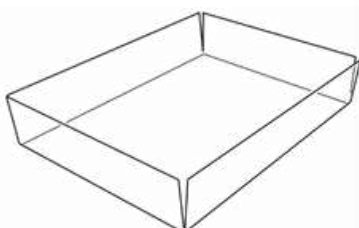

#### Polypropylene Liner - Frosted

To suit WC43 wooden crate - **WC43-PPL**  
To suit WC54 wooden crate - **WC54-PPL**

#### Polycarb Lid - Clear

*Prevents contamination and keep products fresh.*

To suit WC43 wooden crate - **VL43**  
To suit WC54 wooden crate - **VL54**

#### Non-Slip Matt

To suit WC43 wooden crate - **WC43-MAT**  
To suit WC54 wooden crate - **WC54-MAT**

#### EVA Flat Liner

To suit WC43 wooden crate - **WC43-EVA**  
To suit WC54 wooden crate - **WC54-EVA**

# Slanted Wooden Crates

## Slanted Wooden Crate - Premium Finish

450 x 320 x 110-210mm



**WCS53-Aged**  
Aged

**WCS53-P**  
Premium

**WCS53-PDS**  
Dark Stain

**WCS53-PBK**  
Black

**WCS53-PWW**  
White-Wash



**Polypropylene Liner - Frosted**  
Fits WC53-P wooden crate  
**WCS53-PPL**

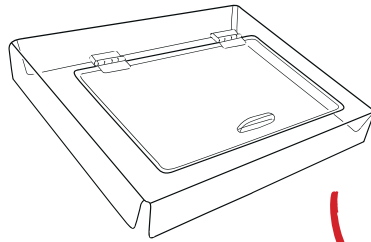

**Polycarb Lid - Clear**  
*Fits WCS53 crates, to prevent contamination and keep products fresh.*  
460 x 340 x 50mm - **VLS53**



**Non-Slip Mat - WCS53-Mat**



**Eva Flat Liner - WCS53-EVA**



**(WCS53-P + VLS53)**

Recommended ticketing for Wooden Crates, more details see p. 68 - 74



**Flexi Plastic A7 Folded Ticket Holder**  
**PTSA7**



Black - **TC1-B**  
Clear - **TC1-C**

Black - **TC25-B**  
Clear - **TC25-C**



**PTHA7-H**  
13mm hook

**PTHA7-V**  
13 mm hook

**PTHDL**  
13mm hook

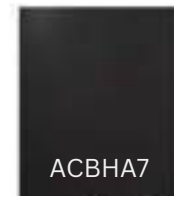

**ACBHA7**  
**Rear-Side Hanging Chalkboards**  
**ACBHA7**  
13mm hook



# Clear-Front Wooden Crates

- While maintaining the market vibe, the clear-front creates a more contemporary look & maximises your customer's view of the produce.



**Clear-Front Wooden Crate - Premium Finish**  
300 x 400 x 95mm  
Natural - **WC43-CF**  
Dark Stain - **WC43-CF-PDS**



**PTHA7-V**  
13mm hook  
*Recommended ticketing for Clear-Front Wooden Crates. For more details see page 69*



**Clear-Front Wooden Crate - Premium Finish**  
400 x 500 x 95mm  
Natural - **WC54-CF**  
Dark Stain - **WC54-CF-PDS**

(All dimensions in millimetres - width x depth x height)

## Long Narrow Wooden Crates

Long Narrow Wooden Crates - Premium Finish

800 x 200 x 130mm



Natural-WC82-P

Dark Stain-WC82-PDS

Black-WC82-PBK

White-Wash-WC82-PWW

## Slat-Sided Wooden Crates



**Small Slat-Sided Wooden Crate - Premium Finish**

340 x 300 x 95mm

Natural - WT33-P

Dark Stain - WT33-PDS

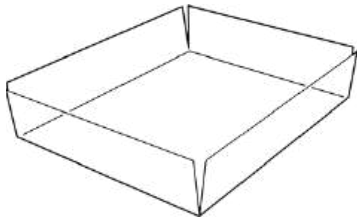

**Small Polypropylene Liner**

*Fits WT33 crate*

WT33-PPL

**Medium Slat-Sided Wooden Crate - Premium Finish**

420 x 340 x 95mm

Natural - WT43-P

Dark Stain - WT43-PDS

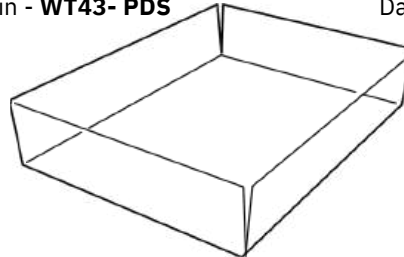

**Medium Polypropylene Liner**

*Fits WT43 crate*

WT43-PPL

**Large Slat-Sided Wooden Crate - Premium Finish**

450 x 310 x 95mm

Natural - WTH53-P

Dark Stain - WTH53-PDS

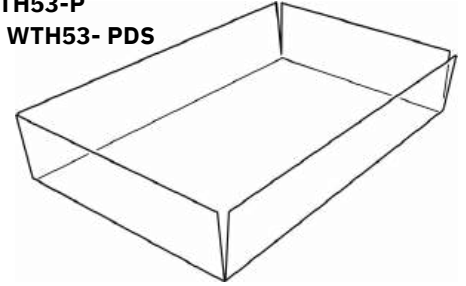

**Large Polypropylene Liner**

*Fits WTH53 crate*

WTH53-PPL

## Deep Square Wooden Crate - Premium Finish

300 x 300 x 230mm



Natural-WC323-P

Dark Stain-WC323-PDS

Black-WC323-PBK

White-Wash-WC323-PWW

## Deep Rectangle Wooden Crate - Premium Finish

400 x 340 x 230mm



Natural-WC434-P

Dark Stain-WC434-PDS

Black-WC434-PBK

White-Wash-WC434-PWW

# Large Open-Slat Wooden Crate - Rustic

560 x 370 x 310mm



Natural-WC053

Aged-WC053-Aged

Dark Stain-WC053-DS

Black-WC053-BK

White-Wash-WC053-WW

## Polycarb Lining

*Food-grade liners to protect your crates  
Fits WCC53 & WCO53*

WCC53-CL

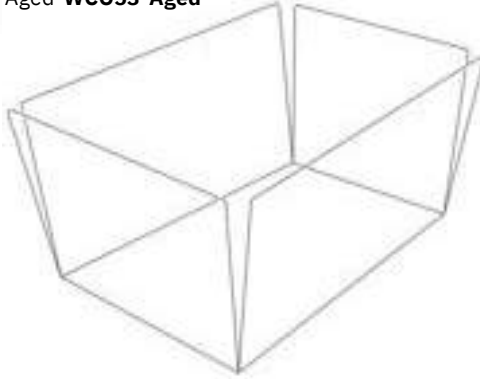

## Clear Polycarb Lid

*Prevent contamination and keep products fresh  
Fits WCC53 & WCO53*

VL-WCC53

# Closed-Sided Wooden Crates - Premium Finish

560 x 370 x 310mm



Natural-WCC53-P

Aged-WCC53P-Aged

Dark Stain-WCC53-PDS

Black-WCC53-PBK

White-Wash-WCC53-PWW



Example



## Wooden Spill-Over Crate

560 x 370 x 110

*Sits on top of WCC53 or WCO53 to create spill-over or island display*

WC53P-SP

Create your own display using our Wooden Crates (3 used 'In-Store' here)

2 x WC053 + WC53P-SP spill-over display



Stencilling available

# Wooden Barrels



**Small Wooden Barrel**  
330mm Ø x 240mm H  
Dark Stain - **BAR320-DS**  
Cherry Pine - **BAR320-CP**

**Wooden Barrel**  
380mm Ø x 270mm H  
Dark Stain - **BAR370-DS**  
Cherry Pine - **BAR370-CP**

**Wooden Barrel**  
450mm Ø x 320mm H  
Dark Stain - **BAR450-DS**  
Cherry Pine - **BAR450-CP**

**Large Wooden Barrel**  
500mm Ø x 350mm H  
Dark Stain - **BAR500-DS**  
Cherry Pine - **BAR500-CP**

**Large Wooden Barrel**  
650mm Ø x 350mm H  
Dark Stain - **BAR650-DS**  
Cherry Pine - **BAR650-CP**



**Barrel MDF Dummy Bases**  
Black - 260mm Ø - **BARDB-320MDF**  
Black - 300mm Ø - **BARDB-370MDF**  
Black - 370mm Ø - **BARDB-450MDF**  
Black - 410mm Ø - **BARDB-500MDF**  
Black - 570mm Ø - **BARDB-650MDF**

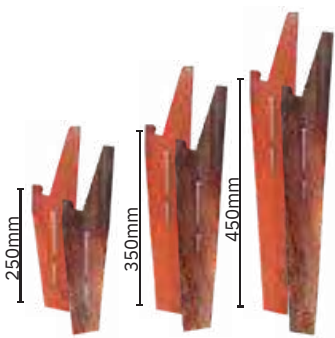

**Wooden Barrel Legs**  
*All legs will fit all barrels, simply choose your preferred height off the ground from 250mm, 350mm or 450mm (screws supplied)*  
**BARLEG250-CP/BARLEG250-DS**  
**BARLEG350-CP/BARLEG350-DS**  
**BARLEG450-CP/BARLEG450-DS**



**Barrel Lids - Clear Polycarb**  
A. **VLA320** (Fits BAR320 barrel)  
B. **VLA370** (Fits BAR370 barrel)



**FS225-SS**



**Utensil Holder (tongs / scoops)**  
*Hang on baskets, crates, display stands, etc*  
125 x 85 x 155mm  
Black - **VUH2-B**  
White - **VUH2-W**



**Barrel Tubs**  
A. **BARTUB320** (Fits BAR320 barrel)  
B. **BARTUB370** (Fits BAR370 barrel)



*Add Price Ticket Holders see page 68*



**Wooden Barrels**  
330mm Ø x 240mm H - **BAR320**  
380mm Ø x 270mm H - **BAR370**





# Wooden Barrels, Stands, Wine & Spirits

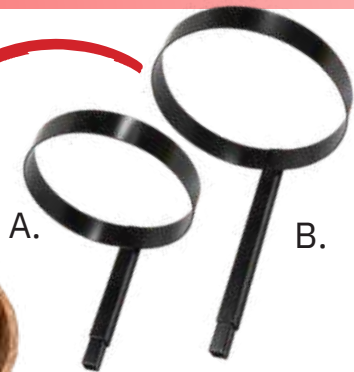

### Metal Barrel-Stand Extensions

Made from Heavy-Duty steel & powder-coated black

- A. **BAR320EXT** - holds BAR320 barrels
- B. **BAR370EXT** - holds BAR370 barrels



### Metal Barrel Stands

Made from Heavy-Duty steel & powder-coated black  
Supplied flat-packed

- A. **BAR650-MS** - 670 x 700 x 660mm - holds BAR650 barrels
- B. **BAR500-MS** - 520 x 550 x 670mm - holds BAR500 barrels

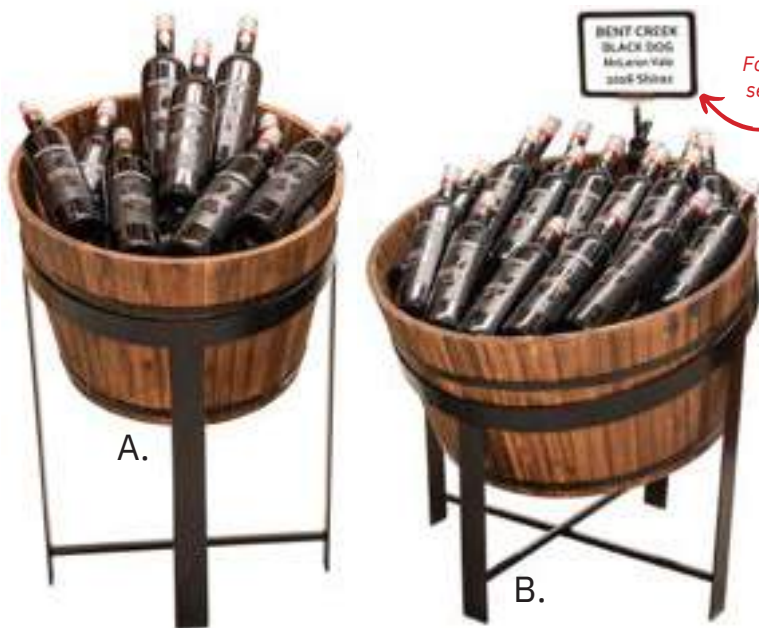

### Wooden Barrels on Tilted Heavy-Duty Steel Stand - Black Powder-Coated

- A. **BAR500-CP** Cherry Pine barrel on **BAR500-MS** tilted stand
- B. **BAR650-CP** Cherry Pine barrel on **BAR650-MS** tilted stand

### Custom Made Wine Bottle Boxes

Premium wine bottle box with sliding polycarb lid  
Other colours available on request

- Black - **WCCL-B**
- Natural - **WCCL-N**



### Rustic Pine Open Wine Bottle Box

400 x 150 x 100mm  
**WC41**



### Wine Bottle Drawstring Bags - Hessian-Look

150 x 340mm  
Olive Green - **HP340-OG**  
Natural - **HP340-N**



### Beer Stand / 5-Tier Premium Wooden Shelf Display with Chalkboard Header

760 x 385 x 1500mm  
Natural - **WS5-5**



For Custom Blackboards featuring your logo  
See Page 72



### Wood Wool (Shredded Pine) x 13kg

600 x 400 x 700mm  
**WW13K**

# Flower Displays



- ALL STANDS ARE **SUPPLIED FLAT-PACKED**



## Flower Barrel, Pot & Stand Set

1 x Heavy-Duty steel stand powder-coated black  
 1 x Wooden Barrel 650mm Ø  
 8 pots - 205mm Ø x 360mm  
 Metal Stand supplied flat packed  
 670 x 700 x 800mm  
 Dark Stain - **FPB660-DS**  
 Cherry Pine - **FPB660-CP**

Display your flower arrangements with vertical height to take up less floor space.



## Flowerpot Stands - with Pots

Included pots - 205mm Ø x 360mm  
 9 -pot stand - 560 x 550 x 1680mm H - **FPS9**  
 12-pot stand - 560 x 550 x 1680mm H - **FPS12**



## Flowerpot Trolley - with Pots

Included pots - 205mm Ø x 360mm  
 6-pot stand - 750 x 640 x 800mm H - **FPT6**  
 9-pot stand - 750 x 640 x 960mm H - **FPT9**



## Flower Trolley with Wooden Shelves

750 x 640 x 800mm



Natural - **FPTWS-N**

*Display boxed or potted flower arrangements*



Dark Stain - **FPTWS-DS**

## 3-Tier Wooden Block Riser Set

900 x 900 x 750mm

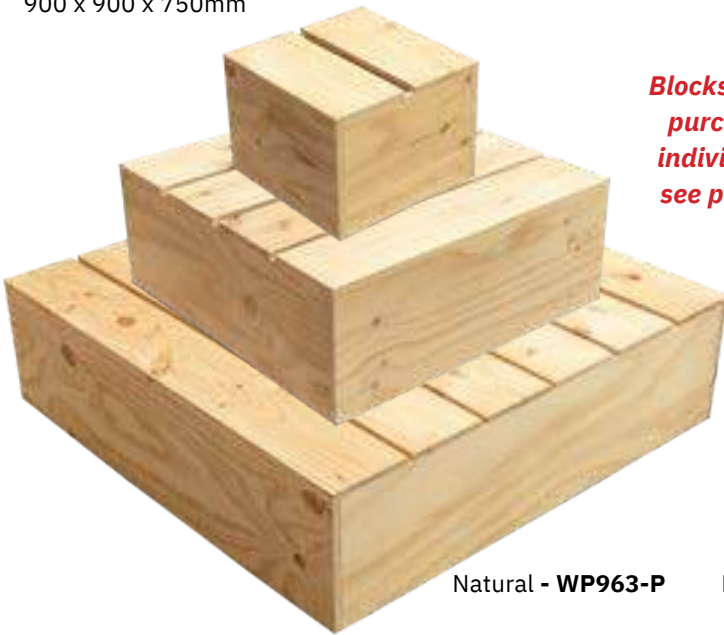

Natural - **WP963-P**

*Blocks can be purchased individually see page 59*



Dark Stain - **WP963-DS**

**NEW**

## 3-Tier Corflute Stand

*Easy to clean  
Supplied flat-packed  
Can hold 200kg  
Light weight  
Handle-slot in rear for ease of mobility*

950 x 750 x 850mm

**Black - FPS3-978-B**



*Easy to assemble  
2 minute assembly*



# Framed Ticketing

## Framed Ticket Holder & Stand Set

*Includes. Frame*

*Ticket Sleeve*

*Extendable Stand*

190mm Ø base x 680-860mm H

### A4

### A5



Black/Black - **TFXA4-BKBK**

Black/Clear - **TFXA4-BKCL**

Chrome/Black - **TFXA4-CBK**

Chrome/Clear - **TFXA4-CCL**

Black/Black - **TFXA5-BKBK**

Chrome/Black - **TFXA5-CBK**

## Framed Ticket Holder Set

*Includes. Frame*

*Ticket Sleeve*

*Thumb-Clamp Ticket-Holder*



A5 - 154 x 217mm (frame size) - **THA5**

A4 - 217 x 303mm (frame size) - **THA4**

A3 - 305 x 560mm (frame size) - **THA3**

**Thumb-Clamp Ticket-Holder**

140mm H

**TCF-BK**

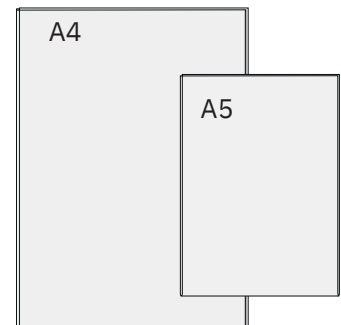
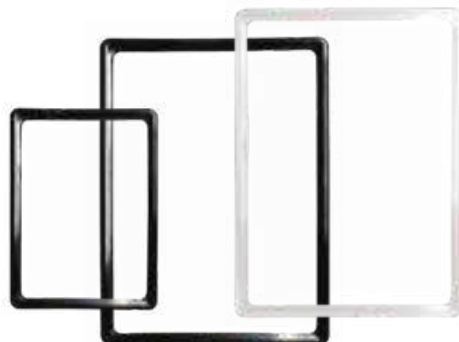

### Extendable Stand with Ticket Frame Clip

190mm Ø base x 380-560mm H extension

A. Black - **TFXP-BK**

B. Chrome - **TFXP-C**

### Ticket Holder Frames - A4 & A5

Black - **TFA5-BK**

Black - **TFA4-BK**

Clear - **TFA4-CL**

### Clear Sleeves - A4 & A5 for Ticket Holder Frames

To fit A4 frames - 209 x 295mm - **TFPS-A4**

To fit A5 frames - 146 x 209mm - **TFPS-A5**

(All dimensions in millimetres - width x depth x height)

# Hanging Ticketing



## 20mm Hook - Ticketing / Brochure Holders *(for Produce Bins & Cabinets)*

- Clear folded Polycarbonate ticket holders to slip printed pricing tickets or signage into
- Hangs over the edge of the produce bins
- Custom sizes available on request
- Rear fold to prevent sagging & corners catching

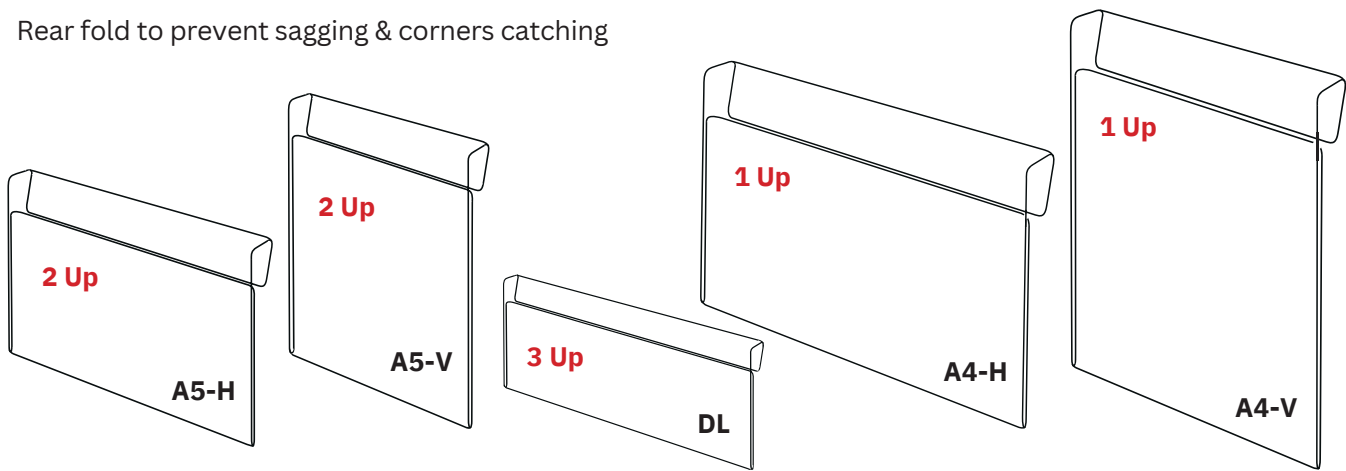

### Clear Hanging Ticket Holders 20mm hook - Polycarb

- A5 - Horizontal** - 215 x 157 x 20mm - **ABHA5-H**
- A5 - Vertical** - 157 x 215 x 20mm - **ABHA5-V**
- DL - Horizontal** - 215 x 115 x 20mm - **ABHDL**
- A4 - Horizontal** - 300 x 215 x 20mm - **ABHA4-H**
- A4 - Vertical** - 215 x 300 x 20mm - **ABHA4-V**

## 13mm Hook - Ticketing / Brochure Holders *(for Refrigeration & Crates)*

### Clear Hanging Ticket Holders 13mm hook - Flexi

- A7 - Horizontal** - 105 x 83 x 13mm - **PTHA7-H**
- A7 - Vertical** - 83 x 110 x 13mm - **PTHA7-V**
- DL - Horizontal** - 215 x 115 x 13mm - **PTHDL**

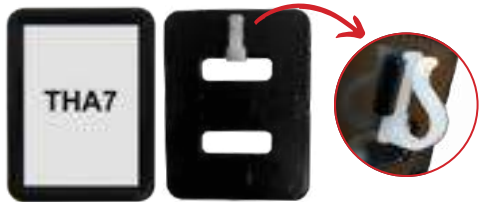
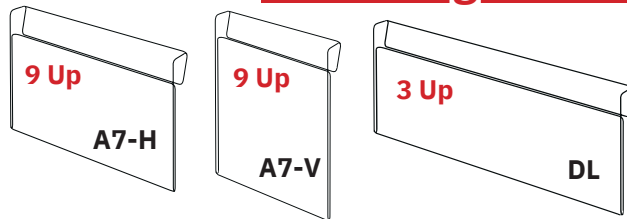

**A7 Mini Frame Kit - (9 up)**  
*Frame, rear hook, PVC sheet*  
 82 x 110 x 6mm  
**THA7**



**A7 Clear Sleeve - Flexi**  
 80 x 110mm  
**THA7-SLEEVE**



**DL Frame Kit - (3 up)**  
*Frame, rear hook, PVC sheet*  
 220 x 110 x 6mm  
**THDL**



**Welded PVC Ticket Pocket with Velcro Tabs**  
*These ticket holders are water tight*  
 81 x 134mm  
**TPV2**



**Ticket Holder with Lugs**  
 70 x 85mm  
**BDTH86**

# Ticketing - Pop Clips

- Super-Strong Polycarb & Stainless Steel
- Flexible with hinges to angle the ticket display
- Different sizes & shapes
- Different sizes to go on crates, bars & barrels etc

**Clear Pop Clip - 85mm H  
TC37-1C**



2 x rod clamps  
+ Single ball joint

**Clear Pop Clip - 90mm H  
TC36-1C**

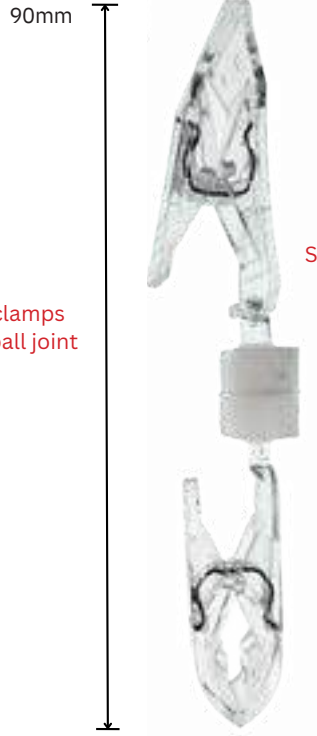

Single ball joint +  
spring loaded  
20mm clip

**Clear Pop Clip - 110mm H  
TC35-1C**

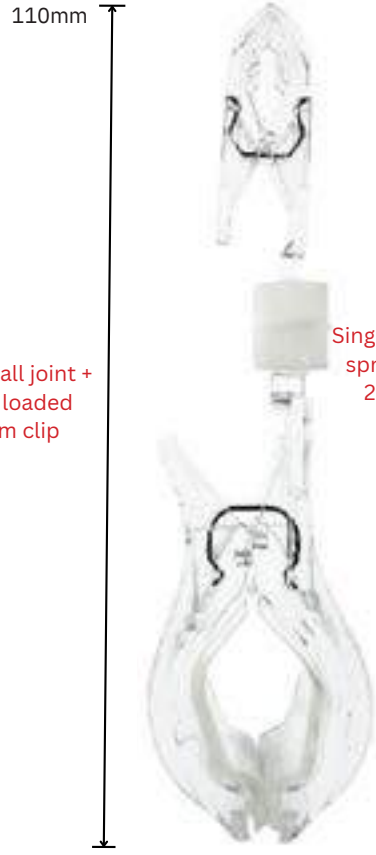

Single ball joint +  
spring loaded  
20mm clip

**Clear Pop Clip - 155mm H  
TC35-2C**

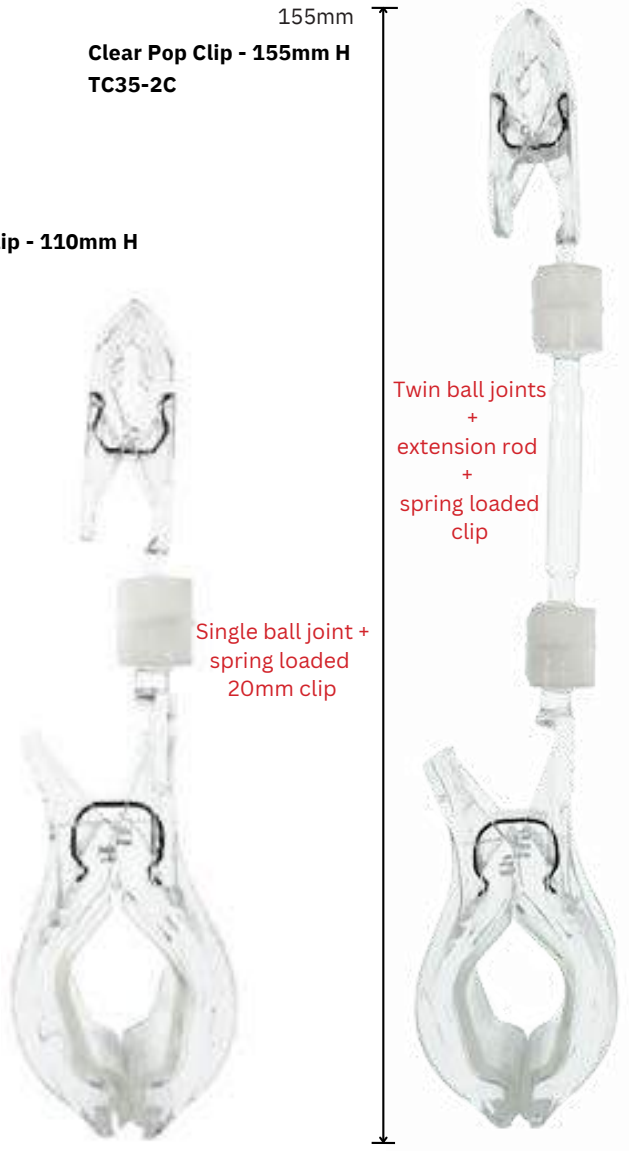

Twin ball joints  
+  
extension rod  
+  
spring loaded  
clip



**Clear Pop Clip - 75mm H  
TC39-1C**



Single ball joint  
+  
50mm  
card holder

**Clear Pop Clip - 70mm H  
TC38-1C**



Single ball joint  
+  
25mm  
card holder

175mm



**Black Thumb Clip -  
175mm H  
TC26-B**

Heavy-duty Multi Joint  
+  
Spring loaded 40mm clip

155mm



**Black Thumb Pop Clip -  
155mm H  
Black - TC25-B**



Clear - TC25-C



Heavy-duty single swivel  
+  
Spring loaded 100mm clip

**Black Thumb Pop Clip - 100mm H**



Black - TC1-B

Single ball joint  
+  
Spring-loaded 80mm clip

100mm



Clear - TC1-C

Single ball joint  
+  
Spring-loaded 80mm clip

# Free-Standing Signage & Ticketing

## Polycarb

### Free-Standing Polycarb Signage Holders on Acrylic Blocks

- A4 - Vertical** 215 x 40 x 315mm - **PCA4BH**
- A5 - Horizontal** 215 x 40 x 165mm - **PCA5BH**
- A6 - Horizontal** 150 x 25 x 125mm - **PCA6BH**
- A7 - Horizontal** 110 x 25 x 95mm - **PCA7HBH**
- A7 - Vertical** 80 x 25 x 120mm - **PCA7VBH**
- DL - Horizontal** 215 x 40 x 120mm - **PCDLBH**

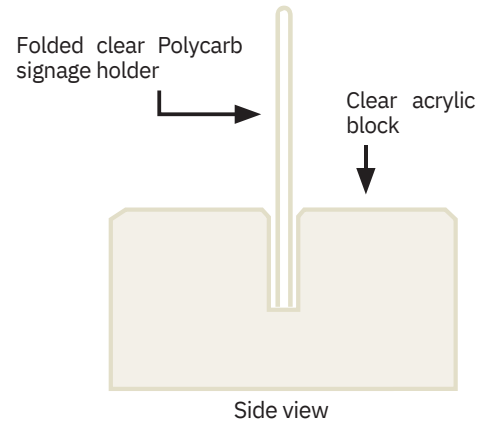

## Acrylic Chalkboards

### Free-Standing Black Acrylic Chalkboards on Oak Blocks

- A3 - 300 x 70 x 420mm - ABBFS-A3**
- A4 - 210 x 70 x 320mm - ABBFS-A4**
- A5 - 150 x 70 x 235mm - ABBFS-A5**
- A6 - 105 x 70 x 170mm - ABBFS-A6**
- A7 - 75 x 70 x 130mm - ABBFS-A7**

*Boards have one side matt finish and one side gloss finish  
Chalkboards are available to buy separately refer page 73.*



Request custom chalkboards featuring your logo.

Chalkboards can be displayed horizontally or vertically in oak block

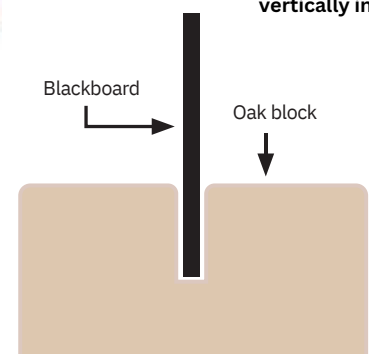



# Deli Ticketing

**Free-Standing Clear Ticket- Holder**  
*Suitable to use with deli bowls*

A. **A8** - 85 x 92 x 165mm H - **DTHA8-FS**  
 B. **A7** - 105 x 70 x 120mm H - **DBTH120-FS**  
 C. **A7** - 105 x 70 x 100mm H - **DBTH100-FS**

**Free-standing Ticket Holders - Stainless Steel**  
*Holds A7 Ticket Holders & Chalkboards*

D. **Ticket Holder/Clip** - 40 x 40 x 100mm - **THSS100-FS**  
 E. **Ticket Holder/Clip** - 40 x 40 x 50mm - **THSS50-FS**

**Adjustable Clear Deli-Ticket Clip (2-piece)**  
 DTC115-C - Clip

**Examples**

Chalkboard ABB-A7, Ticket Sleeve PTSA7-C clear, Ticket Sleeve PTSA7-C, DTC115-C clip, Ticket Sleeve & clip on DB230-75-BK bowl

## Chalkboards & Clear Folded Ticketing for Pop Clips & Free-Standing Holders

**Matt/Gloss Acrylic Chalkboard**  
*Use with Pop Clips, Oak Blocks & Stainless Steel Holders (refer Page 72.)*  
*Can be displayed vertically or horizontally*

**A7 Chalkboard.** 75 x 105mm - **ABB-A7**  
**A6 Chalkboard.** 105 x 150mm - **ABB-A6**  
**A5 Chalkboard.** 150 x 210mm - **ABB-A5**  
**A4 Chalkboard.** 210 x 300mm - **ABB-A4**  
**A3 Chalkboard.** 300 x 400mm - **ABB-A3**

*Chalkboards are 3mm Thick*

**Ticket Holder Sleeve Rigid Plastic - Clear**  
*Use with Pop Clips, Oak Blocks & Stainless Steel Holders (refer Page 72.)*  
*Can be displayed vertically or horizontally*

**A7.** 80 x 110mm - **PTSA7-C**  
**A6.** 110 x 150mm - **PTSA6-C**  
**DL.** 215 x 105mm - **PTSDL-C**

**Example**

PTSA7-C Ticket Holder Sleeve on TC1-B Clip

# Chalkboards & Liquid Chalk



A.

B.

C.

D.

E.

## Hanging Wood-Framed Chalkboards

- A. **Horizontal** - 890 x 450mm - **BBF49**
- B. **Horizontal** - 400 x 300mm - **BBFA2**
- C. **Horizontal** - 380 x 220mm - **BBFA4**
- D. **Horizontal** - 230 x 150mm - **BBFA5**
- E. **Horizontal** - 100 x 50mm - **BBF15**



A.

B.

C.

D/E.

## Liquid Chalk Pen

*All pens have a reversible tip - Bullet & Chisel*

- A. **Liquid Chalk Pen** with 6mm reversible tip - 8-Pack - **LCM6MM-8P** (red, yellow, blue, green, pink, purple, orange, white)
- B. **Liquid Chalk Pen** with 6mm reversible tip - 4-Pack - **LCM6MM-4P** (yellow, blue, pink, white)
- C. **Liquid Chalk Pen** with 6mm reversible tip - 2-Pack - **LCM6MM-2P** (gold, silver)
- D. **Liquid Chalk Pen** with 6mm reversible tip - **LCM6MM-W** (white)
- E. **Liquid Chalk Pen** with 3mm reversible tip - **LCM3MM-W** (white)

## Hanging Chalkboards

*Hook on the back allows these chalkboards to hang  
For hanging on the side of produce bins*

- A5 - Vertical** - 157 x 215 x 20mm - **ACBHA5-V**
- A5 - Horizontal** - 215 x 157 x 20mm - **ACBAHA5-H**
- DL - Horizontal** - 215 x 105 x 20mm - **ACBHDL**
- A4 - Vertical** - 215 x 300 x 20mm - **ACBHA4-V**
- A4 - Horizontal** - 300 x 215 x 20mm - **ACBHA4-H**
- 750 x 405 x 20mm - **ACBH47**
- 750 x 300 x 20mm - **ACBH37**

With optional name plate



A.

B.

C.

D.

E.

## Free-Standing A-Frame Wood-Framed Chalkboards Single-Sided

- A. 415 x 775mm - **BBF47-A**

## Free-Standing A-Frame Wood-Framed Chalkboards Double-Sided

- B. 220 x 370mm - **BBF23-A**
- C. 500 x 860mm - **BBF586-DS**
- D. 500 x 870mm (curved top) - **BBF587-DS**
- E. 690 x 1200mm - **BBF712-DS**

# Legend Card Holders

- Available in A4 & A5
- Highly adhesive tape (3M) on 3 side, secures to any surface
- Opening to slid papers in & out
- Applications:
  - Notices in high traffic areas
  - Lunch rooms
  - Emergency signs
  - Warning labels
  - Bathrooms

FRONT



BACK

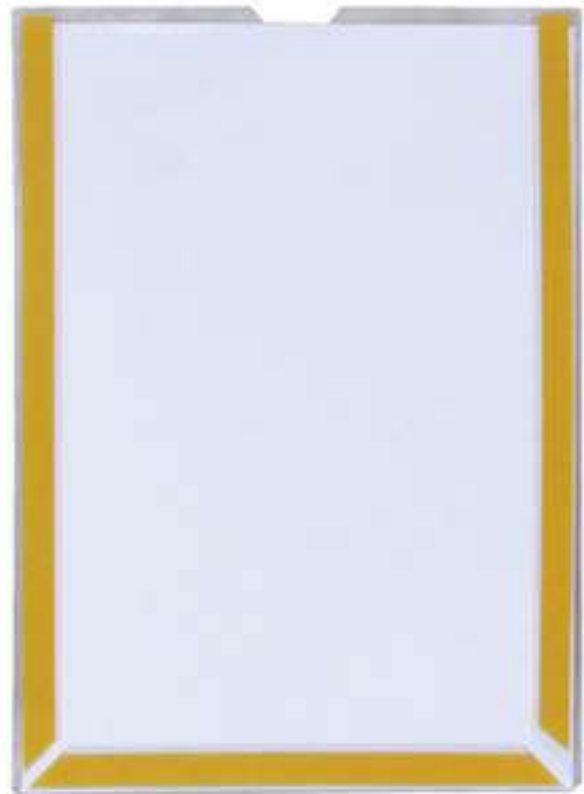

## Legend Card Holders

A4 - LCHA4

A5 - LCHA5



*Examples*





For your convenience, we proudly collaborate with resellers all across Australia and New Zealand.

**For more information, please contact:**

***Fresh Produce Displays***  
**[www.freshproducedisplays.com.au](http://www.freshproducedisplays.com.au)**